

# CAPITAL CRESTING™

AMERICA'S LEADING FABRICATOR OF ROOF CRESTINGS  
BALCONETTE™ WINDOW BOX HOLDERS • FINIALS • SNOWGUARDS • MAILBOX SURROUNDS

**2006 CATALOGUE**

**WWW.CAPITALCRESTINGS.COM**

**(800) 442-4766**

030806A



**Above All Else America's Historic Homes Have Capital Crestings™**

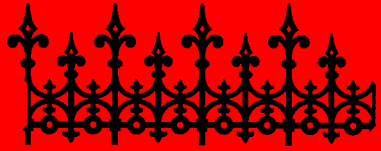

# TABLE OF CONTENTS



<b>Roof Crestings Introduction</b>	
<b>Customer Service Letter.....</b>	<b>3</b>
<b>Photographs.....</b>	<b>4</b>
<b>Cresting Styles.....</b>	<b>5</b>
<i><b>The Regency / The Empire.....</b></i>	<b>6</b>
<i><b>The Balmoral / The Bolero.....</b></i>	<b>7</b>
<i><b>The French Quarter / The Windsor.....</b></i>	<b>8</b>
<i><b>The Chelsea / The Tudor Rose.....</b></i>	<b>9</b>
<i><b>The Gramercy / The Trafalgar.....</b></i>	<b>10</b>
<i><b>The Cortez / The Wellington.....</b></i>	<b>11</b>
<i><b>The Armada / The Continental.....</b></i>	<b>12</b>
<i><b>The Cloisters / The Catalina.....</b></i>	<b>13</b>
<i><b>The Astor Place / The Savannah.....</b></i>	<b>14</b>
<i><b>The Tuscany / The Carlisle.....</b></i>	<b>15</b>
<i><b>The Graerock / The Cosmopolitan.....</b></i>	<b>16</b>
<i><b>The Art Deco.....</b></i>	<b>17</b>
<b>Other Uses For Crestings.....</b>	<b>17</b>
<b>Finials.....</b>	<b>18</b>
<b>Copper Roof Caps</b>	
<b>Assembly Details</b>	
<b>Stand Alone Finial Brackets.....</b>	<b>19</b>
<b>Snowguards / Cresting</b>	
<b>Standard Bracket Detail.....</b>	<b>20</b>
<b>Balconettes - America's Premier</b>	
<b>Window Box Holders .....</b>	<b>21</b>
<b>Firewood / Planter Boxes /</b>	
<b>Mailbox Surrounds.....</b>	<b>22</b>
<b>Ordering Information.....</b>	<b>23</b>
<b>Order Form.....</b>	<b>24</b>
<b>An Invitation</b>	
<b>Custom Grilles</b>	
<b>and Custom Work.....</b>	<b>25</b>
<b>What Else Does</b>	
<b>Architectural Iron Company Do?....</b>	<b>26</b>

# ROOF CRESTINGS

*Elegant details of an era gone by now available  
for your historic or retro-architecture home.*

Remember all those late nineteenth century buildings you've seen...the ones with the crest on every roof, the crown on every cupola and widow's walk, the decorative appointments that commanded the eye skyward. They were the architectural finishing touch in an era obsessed with detail.

With today's renewed interest in historic preservation of our architectural heritage, demand for such crestings is growing. As in the Victorian Era, they are the finishing touch in making your home a showplace, whether your home is a vintage house of the Victorian Era or a Retro-Architecture home commonly seen in new construction. **CAPITAL CRESTINGS** add a touch of class and authenticity to your period home.

Our new online **CAPITAL CRESTING** brochure offers 23 stock designs. Matching finial/corner posts and snowguards are also offered for each cresting design, and are recommended as the finishing touches to a breathtaking installation.

Additionally, Capital Crestings offers Balconette™ window box holders, as well as mailbox surrounds and decorative planter/firewood boxes in coordinated designs to match each cresting.

23 STOCK  
DESIGNS

AFFORDABLE  
LIGHTWEIGHT  
EASY TO INSTALL

GUARANTEED  
UNBREAKABLE



## CAPITAL CRESTING™

AMERICA'S LEADING FABRICATOR  
OF ROOF CRESTINGS  
MANUFACTURED BY ARCHITECTURAL IRON COMPANY  
MILFORD, PENNSYLVANIA

— ABOVE ALL ELSE, AMERICA'S HISTORIC HOMES HAVE CAPITAL CRESTINGS —

800-442-IRON/4766 • 570-296-7722 • FAX 570-296-IRON/4766

www.capitalcrestings.com

e-mail: info@capitalcrestings.com



## ARCHITECTURAL IRON COMPANY CAPITAL CRESTINGS

104 Ironwood Court • P.O. Box 126 • Milford, PA 18337 • 570-296-7722 • 800-442-IRON/4766  
www.capitalcrestings.com • Fax 570-296-IRON/4766 • e-mail: info@capitalcrestings.com

Dear Valued Customer:

Capital Crestings® are manufactured by Architectural Iron Company, the *country's leading manufacturer of decorative roof crestings*. Working in our shops in the Victorian village of Milford, Pennsylvania, our craftsmen produce a complete and growing line of *lightweight, easy to install, unbreakable* roof crestings, finials, snowguards, balconette window box holders, flower boxes, and firewood boxes. They are beautiful, affordably priced, and they can enhance the value and beauty of your home.

All Capital Crestings are made in the USA of US-made materials. Most of our standard designs are based upon previously mass-produced crestings of the Victorian era. We can also reproduce any design that you may supply to us, as we have for many satisfied customers from individual homeowners to public buildings and government edifices. All crestings, whether custom or stock designs, can be produced in custom lengths, heights and colors. Whatever your needs, we are here to help.

After priming and painting, Capital Crestings products are *virtually impervious to the elements* - you should never have to replace them. Our standard designs are made in easy-to-handle four-foot lengths, thus eliminating the hassle of juggling numerous cast iron pieces on a steep roof, a real plus for you or your contractor. Additionally, we include a *lifetime guarantee against breakage*, something that no other manufacturer of those fragile drop-it-once-and-it's-broken cast iron crestings would ever consider. Appropriate assembly hardware is included with all Capital Crestings products to simplify and speed the installation for you. Selecting, purchasing and installing your Capital Crestings products are simple; the results are simply spectacular. Not sure? Representative sample sections are available at a nominal cost, which is refundable on prompt orders. See the quality, workmanship, and beauty for yourself, then decide.

Take a few moments to examine our offerings and make your selections. Feel free to call us at **800-442-IRON/4766** with any questions or comments. We are here to help.

*You've come this far to make your home  
a showplace...Capital Crestings  
are the final touch.*

Sincerely,

Don Quick, President  
ARCHITECTURAL IRON COMPANY



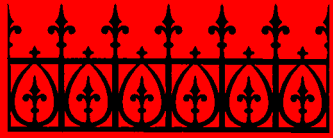

# PHOTOGRAPHS

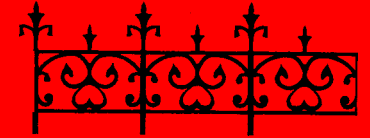

Additional photos are available on our website: [www.capitalcrestings.com](http://www.capitalcrestings.com)



030806A

# CRESTINGS

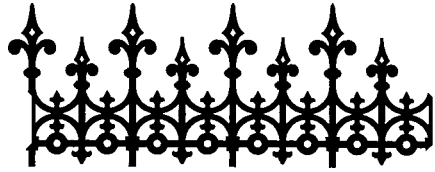

**REGENCY - Style #118**  
18.5" high



**EMPIRE - Style #133**  
13.5" high



**BOLERO - Style #156**  
8.6" high



**WINDSOR - Style #280**  
11" high

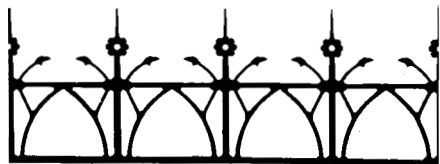

**TUDOR ROSE - Style #383**  
17.5" high



**TRAFALGAR - Style #315**  
12" high

**C**APITAL CRESTINGS™ are available in 23 standard designs. Each of these is shown here and a detail page of each design can be found in the following pages.

Custom designs are also available to match your existing cresting.

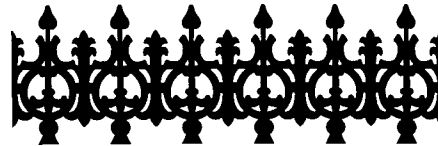

**BALMORAL - Style #151**  
15.6" high



**FRENCH QUARTER - Style #186**  
16.5" high

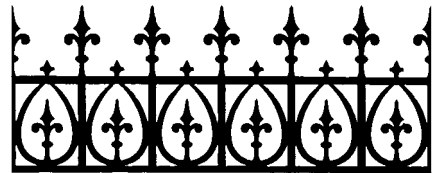

**CHELSEA - Style #315**  
19" high

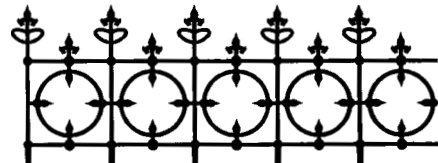

**GRAMERCY - Style #384**  
17.75" high



**CORTEZ - Style #429**  
21.25" high

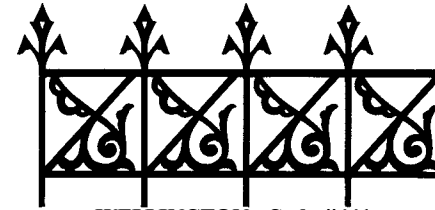

**WELLINGTON - Style #441**  
22.375" high

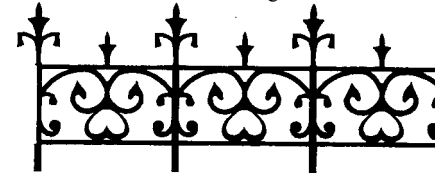

**CONTINENTAL - Style #462**  
18.5" high

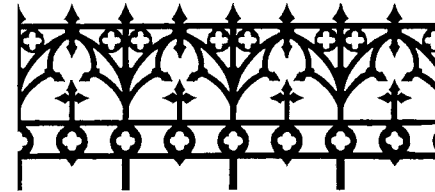

**CATALINA - Style #515**  
20.5" high



**SAVANNAH - Style #531**  
19" high

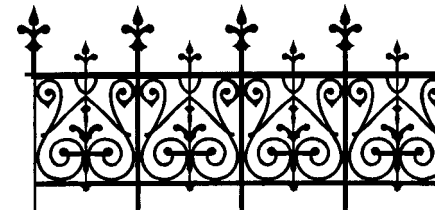

**CARLISLE - Style #561**  
23" high

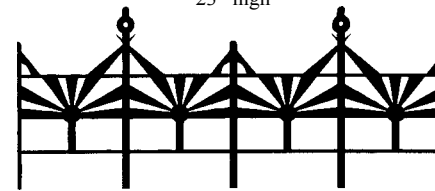

**COSMOPOLITAN - Style #569**  
19" high



**ARMADA - Style #457**  
14.25" high



**CLOISTERS - Style #465**  
15" high

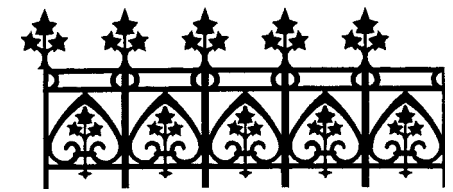

**ASTOR PLACE - Style #518**  
20" high

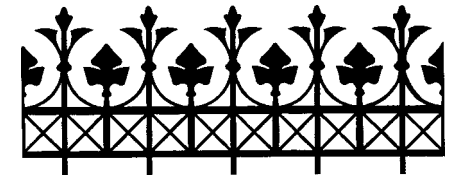

**TUSCANY - Style #557**  
19" high

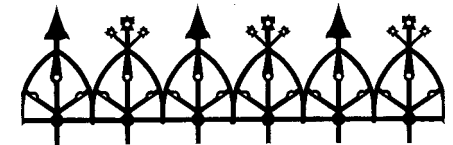

**GRAEROCK - Style #568**  
16" high

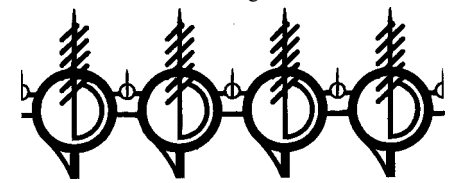

**ART DECO - Style #571**  
20" high

**Our Most Popular Design,  
Gracing Historic Homes Throughout America.  
Available Only from Capital Cresting!**

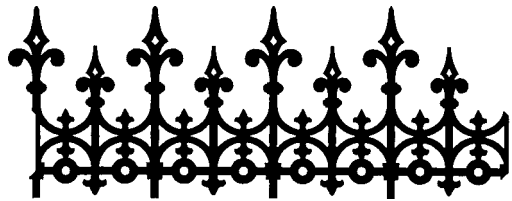

**Regency  
Cresting**

Overall Height: 18.5"  
Overall Length: 47.5"  
Usable Length: 45"

Sample 118SSB - \$25.00 • Refundable with order.

**- CRESTING FABRICATED IN STEEL -**

Item No.	Thickness	Price Each	Weight Each
118CSA	3/16"	\$172.00	14 lbs.
118CSB	1/4"	\$224.50	19 lbs.
118CSC	3/8"	\$272.25	29 lbs.



**Regency  
Snowguard**

5" high • 3.2" wide • 1/8" material  
Steel • Item No. 118GSD • \$21.75

*As Beautiful As They Are Functional!*

**Regency Finial**

35" high • 7.9" wide • 3/16" material  
Steel • Item No. 118FSA • \$116.25



**Regency Balconette**



10" high • 12" deep • 3/16" material

Width	Item No.	Price	Weight	Width	Item No.	Price	Weight
30"	118BSA30	\$327.00	24 lbs.	42"	118BSA42	\$359.00	30 lbs.
36"	118BSA36	\$346.00	27 lbs.	48"	118BSA48	\$392.00	34 lbs.

*Dress Up Your Windows with America's Most Exquisite Window Box Holder!*

**Regency Planter/Firebox**

10" high • 12" deep • 3/16" material

Width	Item No.	Price	Weight
24"	118PSA24	\$299.00	26 lbs.
36"	118PSA36	\$399.00	39 lbs.

*Beautiful & Functional All Year! See Page 22*

**Regency  
Mailbox Surround**

10.75" high • 8" wide  
19.5" long • 3/16" material  
118MSA • 12 lbs. • \$179.00

*See Page 22*

**Gracious • Graceful • Affordable**

**A Touch of Class & Authenticity for Your  
Historic or Retro-Architecture Home!  
Available Only from Capital Cresting!**



**Empire  
Cresting**

Overall Height: 13.5"  
Overall Length: 47.5"  
Usable Length: 47"

Sample 133SSB - \$25.00 • Refundable with order.

**- CRESTING FABRICATED IN STEEL -**

Item No.	Thickness	Price Each	Weight Each
133CSA	3/16"	\$106.00	14 lbs.
133CSB	1/4"	\$123.00	21 lbs.
133CSC	3/8"	\$150.50	28 lbs.



**Empire  
Snowguard**

5.4" high • 4.1" wide • 1/8" material  
Steel • Item No. 133GSD • \$19.25

*As Beautiful As They Are Functional!*

**Empire Finial**

28" high • 4" wide • 3/16" material  
Steel • Item No. 133FSA • \$107.25



**Empire Balconette**



12.25" high • 12" deep • 3/16" material

Width	Item No.	Price	Weight	Width	Item No.	Price	Weight
30"	133BSA30	\$250.50	29 lbs.	42"	133BSA42	\$267.75	36 lbs.
36"	133BSA36	\$262.00	32 lbs.	48"	133BSA48	\$289.00	40 lbs.

*Dress Up Your Windows with America's Most Exquisite Window Box Holder!*

**Empire Planter/Firebox**

10.5" high • 12" deep • 3/16" material

Width	Item No.	Price	Weight
24"	133PSA24	\$229.00	31 lbs.
36"	133PSA36	\$289.00	47 lbs.

*Beautiful & Functional All Year! See Page 22*

**Empire  
Mailbox Surround**

13.25" high • 8" wide  
19.5" long • 3/16" material  
133MSA • 14 lbs. • \$139.00

*See Page 22*

**23 Stock Designs • Custom Work Available**

**Traditional, Contemporary and Custom Designs  
Gracing Historic Homes Throughout America.  
Available Only from Capital Cresting!**

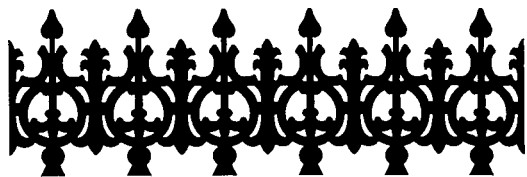

**Balmoral  
Cresting**

Overall Height: 15.6"  
Overall Length: 47.5"  
Usable Length: 47.5"

Sample 151SSB - \$25.00 • Refundable with order.

— CRESTING FABRICATED IN STEEL —

Item No.	Thickness	Price Each	Weight Each
151CSA	3/16"	\$167.00	18 lbs.
151CSB	1/4"	\$180.00	27 lbs.
151CSC	3/8"	\$204.50	36 lbs.



**Balmoral Finial**

31" high • 6" wide • 3/16" material  
Steel • Item No. 151FSA • \$119.25



**Balmoral  
Snowguard**

5.25" high • 4.1" wide • 1/8" material  
Steel • Item No. 151GSD • \$22.50

*As Beautiful As They Are Functional!*



**Balmoral Balconette**

10.5" high • 12" deep • 3/16" material

Width	Item No.	Price	Weight	Width	Item No.	Price	Weight
30"	151BSA30	\$319.00	28 lbs.	42"	151BSA42	\$350.75	35 lbs.
36"	151BSA36	\$335.50	32 lbs.	48"	151BSA48	\$371.75	40 lbs.

*Dress Up Your Windows with America's Most Exquisite Window Box Holder!*

**Balmoral Planter/Firebox**

10.5" high • 12" deep • 3/16" material

Width	Item No.	Price	Weight
24"	151PSA24	\$299.00	31 lbs.
36"	151PSA36	\$399.00	47 lbs.

*Beautiful & Functional All Year! See Page 22*

**Balmoral  
Mailbox Surround**

11.25" high • 8" wide  
19.5" long • 3/16" material  
151MSA • 14 lbs. • \$159.00

*See Page 22*

**Lightweight • Unbreakable • Easy to Install**

**A Touch of Class & Authenticity for Your  
Historic or Retro-Architecture Home!  
Available Only from Capital Cresting!**



**Bolero  
Cresting**

Overall Height: 8.6"  
Overall Length: 47.5"  
Usable Length: 46"

Sample 156SSB - \$25.00 • Refundable with order.

— CRESTING FABRICATED IN STEEL —

Item No.	Thickness	Price Each	Weight Each
156CSA	3/16"	\$75.75	10 lbs.
156CSB	1/4"	\$85.25	15 lbs.
156CSC	3/8"	\$102.50	20 lbs.

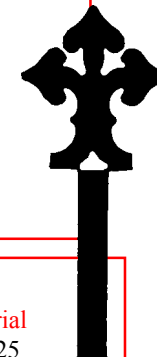

**Bolero Finial**

17" high • 7" wide • 3/16" material  
Steel • Item No. 156FSA • \$85.25



**Bolero  
Snowguard**

5.0" high • 5.67" wide • 1/8" material  
Steel • Item No. 156GSD • \$20.50

*As Beautiful As They Are Functional!*



**Bolero Balconette**

6.5" high • 12" deep • 3/16" material

Width	Item No.	Price	Weight	Width	Item No.	Price	Weight
30"	156BSA30	\$179.00	24 lbs.	42"	156BSA42	\$239.00	30 lbs.
36"	156BSA36	\$219.50	27 lbs.	48"	156BSA48	\$259.75	33 lbs.

*Dress Up Your Windows with America's Most Exquisite Window Box Holder!*

**Bolero Planter/Firebox**

6.5" high • 12" deep • 3/16" material

Width	Item No.	Price	Weight
24"	156PSA24	\$229.00	25 lbs.
36"	156PSA36	\$289.00	38 lbs.

*Beautiful & Functional All Year! See Page 22*

**Bolero  
Mailbox Surround**

7" high • 8" wide  
19.5" long • 3/16" material  
156MSA • 12 lbs. • \$139.00

*See Page 22*

**Assembly Hardware Included • Easy to Install**

**Traditional, Contemporary and Custom Designs  
Gracing Historic Homes Throughout America.  
Available Only from Capital Cresting!**

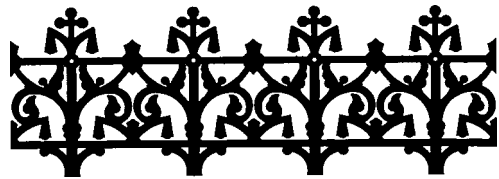

**French Quarter  
Cresting**

Overall Height: 16.5" Overall  
Length: 47.5"  
Usable Length: 47.5"

Sample 186SSB - \$25.00 • Refundable with order.

— CRESTING FABRICATED IN STEEL —

Item No.	Thickness	Price Each	Weight Each
186CSA	3/16"	\$165.75	17.5 lbs.
186CSB	1/4"	\$184.25	24 lbs.
186CSC	3/8"	\$214.50	35 lbs.



**French Quarter Finials**

33" high • 6.25" wide • 3/16" material  
Steel • 186FSA1 • \$157.25

33" high • 12" wide • 3/16" material  
Steel • 186FSA2 • \$158.50



**French Quarter  
Snowguard**

5" high • 3" wide • 1/8" material  
Steel • Item No. 186GSD • \$21.50

*As Beautiful As They Are Functional!*

**French Quarter Balconette**

13.75" high • 12" deep • 3/16" material

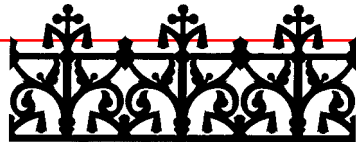

Width	Item No.	Price	Weight	Width	Item No.	Price	Weight
30"	186BSA30	\$254.50	34 lbs.	42"	186BSA42	\$281.25	42 lbs.
36"	186BSA36	\$269.50	38 lbs.	48"	186BSA48	\$298.25	46 lbs.

*Dress Up Your Windows with America's Most Exquisite Window Box Holder!*

**French Quarter Planter/Firebox**

13.75" high • 12" deep • 3/16" material

Width	Item No.	Price	Weight
24"	186PSA24	\$259.00	36 lbs.
36"	186PSA36	\$299.00	54 lbs.

*Beautiful, Elegant & Functional in All Seasons!*

**French Quarter  
Mailbox Surround**

15" high • 8" wide  
19.5" long • 3/16" material  
186MSA • 16 lbs. • \$139.00

*See Page 22*

**A Touch of Class & Authenticity for Your  
Historic or Retro-Architecture Home!  
Available Only from Capital Cresting!**



**Windsor  
Cresting**

Overall Height: 11"  
Overall Length: 47.5"  
Usable Length: 47.5"

Sample 280SSB - \$25.00 • Refundable with order.

— CRESTING FABRICATED IN STEEL —

Item No.	Thickness	Price Each	Weight Each
280CSA	3/16"	\$85.75	8.5 lbs.
280CSB	1/4"	\$97.00	13 lbs.
280CSC	3/8"	\$114.25	17 lbs.

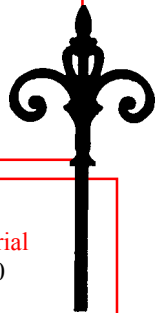

**Windsor Finial**

22" high • 9.75" wide • 3/16" material  
Steel • Item No. 280FSA • \$72.50

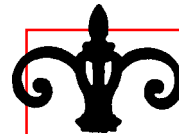

**Windsor  
Snowguard**

5" high • 6.7" wide • 1/8" material  
Steel • Item No. 280GSD • \$23.75

*As Beautiful As They Are Functional!*

**Windsor Balconette**

10.75" high • 12" deep • 3/16" material



Width	Item No.	Price	Weight	Width	Item No.	Price	Weight
30"	280BSA30	\$263.00	25 lbs.	42"	280BSA42	\$280.50	32 lbs.
36"	280BSA36	\$274.75	29 lbs.	48"	280BSA48	\$300.25	36 lbs.

*Dress Up Your Windows with America's Most Exquisite Window Box Holder!*

**Windsor Planter/Firebox**

10.75" high • 12" deep • 3/16" material

Width	Item No.	Price	Weight
24"	280PSA24	\$259.00	27 lbs.
36"	280PSA36	\$299.00	41 lbs.

*Beautiful & Functional All Year! See Page 8*

**Windsor  
Mailbox Surround**

11.5" high • 8" wide  
19.5" long • 3/16" material  
280MSA • 13 lbs. • \$139.00

*See Page 22*

**Finish Your Cresting with a Matching Finial/Corner Post**

**CAPITAL CRESTING**

info@capitalcrestings.com

PAGE 8

**CAPITAL CRESTING**

Call 800-442-4766

030806A

**Traditional, Contemporary and Custom Designs  
Gracing Historic Homes Throughout America.  
Available Only from Capital Cresting!**

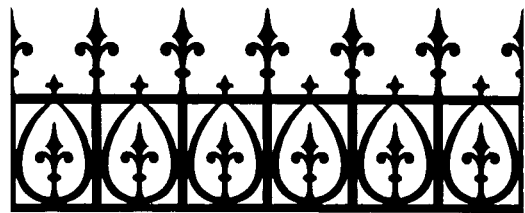

**Chelsea  
Cresting**

Overall Height: 19"  
Overall Length: 47.5"  
Usable Length: 47.5"

Sample 315SSB - \$25.00 • Refundable with order.

**- CRESTING FABRICATED IN STEEL -**

Item No.	Thickness	Price Each	Weight Each
315CSA	3/16"	\$115.50	16.5 lbs.
315CSB	1/4"	\$152.75	25 lbs.
315CSC	3/8"	\$191.50	33 lbs.



**Chelsea  
Snowguard**

5" high • 2.5" wide • 1/8" material  
Steel • Item No. 315GSD • \$20.00  
*As Beautiful As They Are Functional!*

**Chelsea Finial**

35" high • 7.1" wide • 3/16" material  
Steel • Item No. 315FSA • \$112.50



**Chelsea Balconette**



13.75" high • 12" deep • 3/16" material

Width	Item No.	Price	Weight	Width	Item No.	Price	Weight
30"	315BSA30	\$267.00	28 lbs.	42"	315BSA42	\$287.25	35 lbs.
36"	315BSA36	\$282.00	31 lbs.	48"	315BSA48	\$315.00	39 lbs.

*Dress Up Your Windows with America's Most Exquisite Window Box Holder!*

**Chelsea Planter/Firebox**

13.75" high • 12" deep • 3/16" material

Width	Item No.	Price	Weight
24"	315PSA24	\$259.00	31 lbs.
36"	315PSA36	\$339.00	46 lbs.

*Beautiful & Functional All Year! See Page 22*

**Chelsea Mailbox  
Surround**

15" high • 8" wide  
19.5" long • 3/16" material  
315MSA • 13 lbs. • \$139.00

*See Page 22*

**A Touch of Class & Authenticity for Your  
Historic or Retro-Architecture Home!  
Available Only from Capital Cresting!**

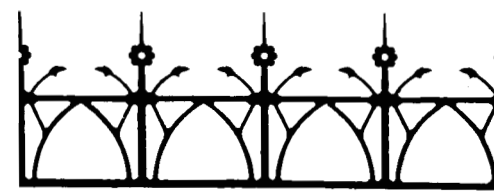

**Tudor Rose  
Cresting**

Overall Height: 17.5"  
Overall Length: 47.5"  
Usable Length: 47.5"

Sample 383SSB - \$25.00 • Refundable with order.

**- CRESTING FABRICATED IN STEEL -**

Item No.	Thickness	Price Each	Weight Each
383CSA	3/16"	\$106.25	8.30 lbs.
383CSB	1/4"	\$127.25	11.0 lbs.
383CSC	3/8"	\$157.50	16.6 lbs.

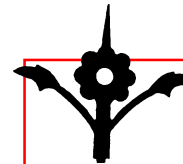

**Tudor Rose  
Snowguard**

5" high • 5.8" wide • 1/8" material  
Steel • Item No. 383GSD • \$21.75  
*As Beautiful As They Are Functional!*

**Tudor Rose Finial**

35" high • 7.25" wide • 3/16" material  
Steel • Item No. 383FSA • \$114.50

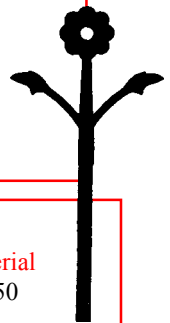

**Tudor Rose Balconette**

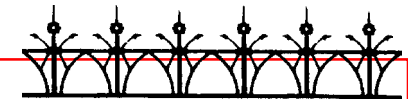

8.75" high • 12" deep • 3/16" material

Width	Item No.	Price	Weight	Width	Item No.	Price	Weight
30"	383BSA30	\$278.50	19 lbs.	42"	383BSA42	\$300.00	24 lbs.
36"	383BSA36	\$291.75	22 lbs.	48"	383BSA48	\$323.00	27 lbs.

*Dress Up Your Windows with America's Most Exquisite Window Box Holder!*

**Tudor Rose Planter/Firebox**

8.75" high • 12" deep • 3/16" material

Width	Item No.	Price	Weight
24"	383PSA24	\$299.00	21 lbs.
36"	383PSA36	\$339.00	31 lbs.

*Beautiful & Functional All Year! See Page 22*

**Tudor Rose  
Mailbox Surround**

9.5" high • 8" wide  
19.5" long • 3/16" material  
383MSA • 10 lbs. • \$139.00

*See Page 22*

**Lightweight • Unbreakable • Easy to Install**

**Coordinate Your Roof Crestings with Matching Balconettes**

**A Touch of Class & Authenticity for Your  
Historic or Retro-Architecture Home!  
Available Only from Capital Cresting!**

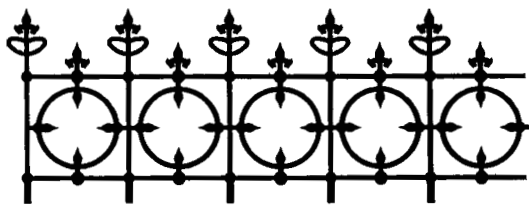

**Gramercy  
Cresting**

Overall Height: 17.75"  
Overall Length: 47.5"  
Usable Length: 46"

Sample 384SSB - \$25.00 • Refundable with order.

**— CRESTING FABRICATED IN STEEL —**

Item No.	Thickness	Price Each	Weight Each
384CSA	3/16"	\$119.75	10 lbs.
384CSB	1/4"	\$139.25	13.5 lbs.
384CSC	3/8"	\$159.25	20 lbs.

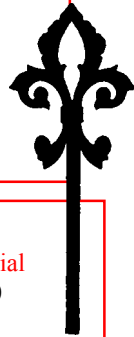

**Gramercy Finial**

35" high • 11.1" wide • 3/16" material  
Steel • Item No. 384FSA • \$92.50



**Gramercy  
Snowguard**

5" high • 2.75" wide • 1/8" material  
Steel • Item No. 384GSD • \$23.75

*As Beautiful As They Are Functional!*

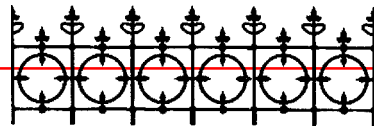

**Gramercy Balconette**

11.75" high • 12" deep • 3/16" material

Width	Item No.	Price	Weight	Width	Item No.	Price	Weight
30"	384BSA30	\$297.25	23 lbs.	42"	384BSA42	\$323.25	28 lbs.
36"	384BSA36	\$313.75	25 lbs.	48"	384BSA48	\$347.75	32 lbs.

*Dress Up Your Windows with America's Most Exquisite Window Box Holder!*

**Gramercy Planter/Firebox**

11.75" high • 12" deep • 3/16" material

Width	Item No.	Price	Weight
24"	384PSA24	\$299.00	23 lbs.
36"	384PSA36	\$339.00	35 lbs.

*Beautiful & Functional All Year! See Page 22*

**Gramercy  
Mailbox Surround**

12.75" high • 8" wide  
19.5" long • 3/16" material  
384MSA • 11 lbs. • \$159.00

*See Page 22*

**Made in the America of U.S. Made Materials**

**Traditional, Contemporary and Custom Designs  
Gracing Historic Homes Throughout America.  
Available Only from Capital Cresting!**

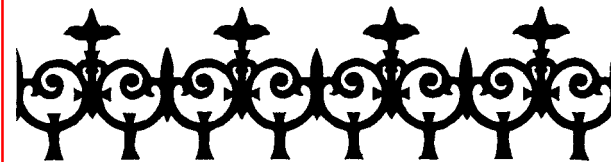

**Trafalgar  
Cresting**

Overall Height: 12" • Overall Length: 47.5" • Usable Length: 47.5"

Sample 425SSB - \$25.00 • Refundable with order.

**— CRESTING FABRICATED IN STEEL —**

Item No.	Thickness	Price Each	Weight Each
425CSA	3/16"	\$134.50	9 lbs.
425CSB	1/4"	\$143.00	13 lbs.
425CSC	3/8"	\$170.25	19 lbs.



**Trafalgar Finial**

24" high • 12.75" wide • 3/16" material  
Steel • Item No. 425FSA • \$87.25

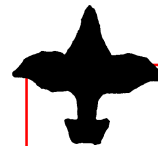

**Trafalgar  
Snowguard**

4" high • 4.5" wide • 1/8" material  
Steel • Item No. 425GSD • \$19.25

*As Beautiful As They Are Functional!*



**Trafalgar Balconette**

12.25" high • 12" deep • 3/16" material

Width	Item No.	Price	Weight	Width	Item No.	Price	Weight
30"	425BSA30	\$238.50	26 lbs.	42"	425BSA42	\$262.75	32 lbs.
36"	425BSA36	\$251.00	29 lbs.	48"	425BSA48	\$271.75	36 lbs.

*Dress Up Your Windows with America's Most Exquisite Window Box Holder!*

**Trafalgar Planter/Firebox**

12.25" high • 12" deep • 3/16" material

Width	Item No.	Price	Weight
24"	425PSA24	\$229.00	30 lbs.
36"	425PSA36	\$289.00	44 lbs.

*Beautiful & Functional All Year! See Page 22*

**Trafalgar Mailbox  
Surround**

13.25" high • 8" wide  
19.5" long • 3/16" material  
425MSA • 13 lbs. • \$139.00

*See Page 22*

**Gracious • Graceful • Affordable**

**A Touch of Class & Authenticity for Your  
Historic or Retro-Architecture Home!  
Available Only from Capital Cresting!**

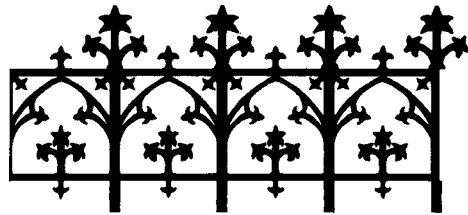

**Cortez  
Cresting**

Overall Height: 21.25"  
Overall Length: 47.5"  
Usable Length: 45"

Sample 429SSB - \$25.00 • Refundable with order.

**- CRESTING FABRICATED IN STEEL -**

Item No.	Thickness	Price Each	Weight Each
429CSA	3/16"	\$135.75	16.5 lbs.
429CSB	1/4"	\$143.00	22 lbs.
429CSC	3/8"	\$170.25	33 lbs.

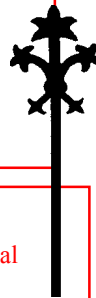

**Cortez Finial**

34.75" high • 9" wide • 3/16" material  
Steel • Item No. 429FSA • \$81.50



**Cortez  
Snowguard**

7 1/8" high • 6.5" wide • 1/8" material only  
Steel • Item No. 429GSD • \$20.50

*As Beautiful As They Are Functional!*

**Cortez Balconette**



11.50" high • 12" deep • 3/16" material

Width	Item No.	Price	Weight	Width	Item No.	Price	Weight
30"	429BSA30	\$272.00	26 lbs.	42"	429BSA42	\$293.00	33 lbs.
36"	429BSA36	\$286.00	29 lbs.	48"	429BSA48	\$306.00	36 lbs.

*Dress Up Your Windows with America's Most Exquisite Window Box Holder!*

**Cortez Planter/Firebox**

11.50" high • 12" deep • 3/16" material

Width	Item No.	Price	Weight
24"	429PSA24	\$259.00	28 lbs.
36"	429PSA36	\$299.00	42 lbs.

*Beautiful & Functional All Year! See Page 22*

**Cortez Mailbox  
Surround**

12.5" high • 8" wide  
19.5" long • 3/16" material  
428MSA • 13 lbs. • \$199.00

*See Page 22*

**23 Stock Designs • Custom Work Available**

**Traditional, Contemporary and Custom Designs  
Gracing Historic Homes Throughout America.  
Available Only from Capital Cresting!**

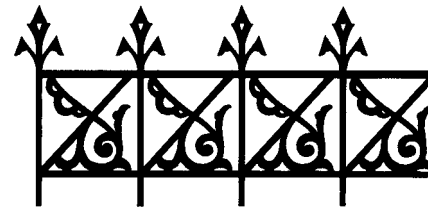

**Wellington  
Cresting**

Overall Height: 22 3/8"  
Overall Length: 47.5"  
Usable Length: 45"

Sample 441SSB - \$25.00 • Refundable with order.

**- CRESTING FABRICATED IN STEEL -**

Item No.	Thickness	Price Each	Weight Each
441CSA	3/16"	\$175.75	16 lbs.
441CSB	1/4"	\$185.50	22 lbs.
441CSC	3/8"	\$214.25	33 lbs.

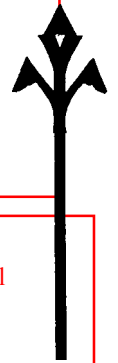

**Wellington Finial**

35" high • 8.0" wide • 3/16" material  
Steel • Item No. 441FSA • \$82.50



**Wellington  
Snowguard**

7.25" high • 5.5" wide • 1/8" material  
Steel • Item No. 441GSD • \$21.50

*As Beautiful As They Are Functional!*

**Wellington Balconette**

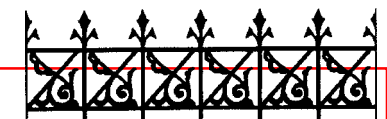

12" high • 12" deep • 3/16" material

Width	Item No.	Price	Weight	Width	Item No.	Price	Weight
30"	441BSA30	\$319.00	26 lbs.	42"	441BSA42	\$349.50	33 lbs.
36"	441BSA36	\$337.75	29 lbs.	48"	441BSA48	\$375.50	36 lbs.

*Dress Up Your Windows with America's Most Exquisite Window Box Holder!*

**Wellington Planter/Firebox**

12" high • 12" deep • 3/16" material

Width	Item No.	Price	Weight
24"	441PSA24	\$299.00	28 lbs.
36"	441PSA36	\$399.00	42 lbs.

*Beautiful & Functional All Year! See Page 22*

**Wellington  
Mailbox Surround**

13" high • 8" wide  
19.5" long • 3/16" material  
441MSA • 13 lbs. • \$159.00

*See Page 22*

**Lightweight • Unbreakable • Easy to Install**

**A Touch of Class & Authenticity for Your  
Historic or Retro-Architecture Home!  
Available Only from Capital Cresting!**

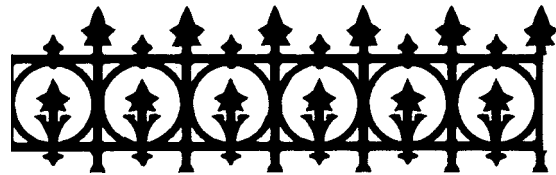

**Armada  
Cresting**

Overall Height: 14.25"  
Overall Length: 47.5"  
Usable Length: 46"

Sample 457SSB - \$25.00 • Refundable with order.

**- CRESTING FABRICATED IN STEEL -**

Item No.	Thickness	Price Each	Weight Each
457CSA	3/16"	\$141.75	14.0 lbs.
457CSB	1/4"	\$147.75	18.5 lbs.
457CSC	3/8"	\$169.25	28.0 lbs.

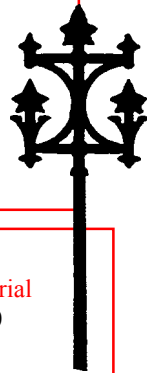

**Armada Finial**

28.25" high • 10" wide • 3/16" material  
Steel • Item No. 457FSA • \$94.50

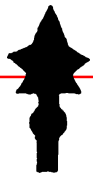

**Armada  
Snowguard**

6.5" high • 3" wide • 1/8" material  
Steel • Item No. 457GSD • \$19.25

*As Beautiful As They Are Functional!*

**Armada Balconette**



11.25" high • 12" deep • 3/16" material

Width	Item No.	Price	Weight	Width	Item No.	Price	Weight
30"	457BSA30	\$274.50	28 lbs.	42"	457BSA42	\$295.25	35 lbs.
36"	457BSA36	\$288.50	32 lbs.	48"	457BSA48	\$324.50	39 lbs.

*Dress Up Your Windows with America's Most Exquisite Window Box Holder!*

**Armada Planter/Firebox**

11.25" high • 12" deep • 3/16" material

Width	Item No.	Price	Weight
24"	457PSA24	\$259.00	31 lbs.
36"	457PSA36	\$339.00	46 lbs.

*Beautiful & Functional All Year! See Page 22*

**Armada  
Mailbox Surround**

12.25" high • 8" wide  
19.5" long • 3/16" material  
457MSA • 14 lbs. • \$139.00

*See Page 22*

**Assembly Hardware Included • Easy to Install**

**Traditional, Contemporary and Custom Designs  
Gracing Historic Homes Throughout America.  
Available Only from Capital Cresting!**

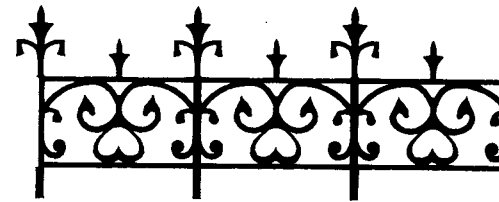

**Continental  
Cresting**

Overall Height: 18.5"  
Overall Length: 47.5"  
Usable Length: 45"

Sample 462SSB - \$25.00 • Refundable with order.

**- CRESTING FABRICATED IN STEEL -**

Item No.	Thickness	Price Each	Weight Each
462CSA	3/16"	\$133.75	10 lbs.
462CSB	1/4"	\$140.75	13 lbs.
462CSC	3/8"	\$164.00	20 lbs.

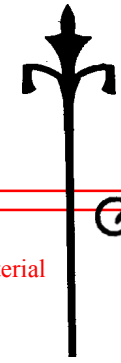

**Continental Finials**

30" high • 6" wide • 3/16" material  
Steel • 462FSA1 • \$78.75



**Continental  
Snowguard**

6.75" high • 4 5/8" wide  
1/8" material

Steel • Item No. 462GSD  
\$20.25

35" high • 10.5" wide • 3/16" material  
Steel • 462FSA2 • \$153.00

**Continental Balconette**

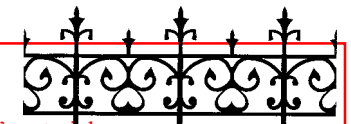

13.75" high • 12" deep • 3/16" material

Width	Item No.	Price	Weight	Width	Item No.	Price	Weight
30"	462BSA30	\$251.50	24 lbs.	42"	462BSA42	\$266.50	31 lbs.
36"	462BSA36	\$259.00	28 lbs.	48"	462BSA48	\$283.00	34 lbs.

*Dress Up Your Windows with America's Most Exquisite Window Box Holder!*

**Continental Planter/Firebox**

13.75" high • 12" deep • 3/16" material

Width	Item No.	Price	Weight
24"	462PSA24	\$229.00	27 lbs.
36"	462PSA36	\$289.00	40 lbs.

*Beautiful, Elegant & Functional in All Seasons!*

**Continental  
Mailbox Surround**

15" high • 8" wide  
19.5" long • 3/16" material  
462MSA • 12 lbs. • \$139.00

*See Page 22*

**Finish Your Cresting with a Matching Finial/Corner Post**

**A Touch of Class & Authenticity for Your  
Historic or Retro-Architecture Home!  
Available Only from Capital Cresting!**

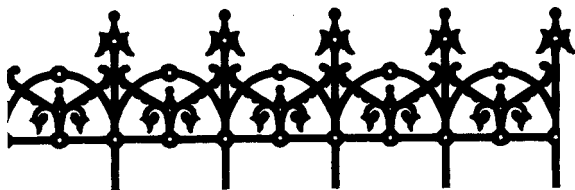

**Cloisters  
Cresting**

Overall Height: 15"  
Overall Length: 47.5"  
Usable Length: 46"

Sample 465SSB - \$25.00 • Refundable with order.

**- CRESTING FABRICATED IN STEEL -**

Item No.	Thickness	Price Each	Weight Each
465CSA	3/16"	\$169.25	11 lbs.
465CSB	1/4"	\$174.75	15 lbs.
465CSC	3/8"	\$204.50	22 lbs.

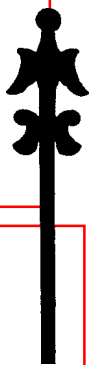

**Cloisters Finial**

30" high • 3.5" wide • 3/16" material  
Steel • Item No. 465FSA • \$76.75

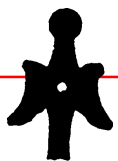

**Cloisters  
Snowguard**

5" high • 3 3/8" wide • 1/8" material  
Steel • Item No. 465GSD • \$20.25

*As Beautiful As They Are Functional!*

**Cloisters Balconette**



9.75" high • 12" deep • 3/16" material

Width	Item No.	Price	Weight	Width	Item No.	Price	Weight
30"	465BSA30	\$268.50	23 lbs.	42"	465BSA42	\$288.00	29 lbs.
36"	465BSA36	\$281.50	26 lbs.	48"	465BSA48	\$308.25	33 lbs.

*Dress Up Your Windows with America's Most Exquisite Window Box Holder!*

**Cloisters Planter/Firebox**

9.75" high • 12" deep • 3/16" material

Width	Item No.	Price	Weight
24"	465PSA24	\$259.00	25 lbs.
36"	465PSA36	\$299.00	37 lbs.

*Beautiful & Functional All Year! See Page 22*

**Cloisters  
Mailbox Surround**

10.5" high • 8" wide  
19.5" long • 3/16" material  
465MSA • 11 lbs. • \$139.00

*See Page 22*

**Elegant • Affordable • Easy to Install**

**Traditional, Contemporary and Custom Designs  
Gracing Historic Homes Throughout America.  
Available Only from Capital Cresting!**

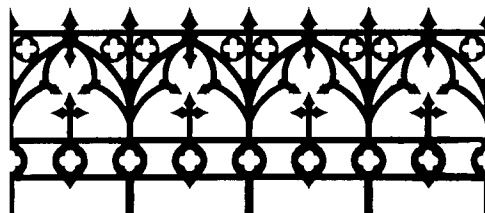

**Catalina  
Cresting**

Overall Height: 20.5"  
Overall Length: 47.5"  
Usable Length: 47.5"

Sample 515SSB - \$25.00 • Refundable with order.

**- CRESTING FABRICATED IN STEEL -**

Item No.	Thickness	Price Each	Weight Each
515CSA	3/16"	\$181.00	16 lbs.
515CSB	1/4"	\$201.75	24 lbs.
515CSC	3/8"	\$231.75	32 lbs.



**Catalina Finial**

33" high • 8" wide • 3/16" material  
Steel • Item No. 515FSA • \$81.25



**Catalina  
Snowguard**

6.2" high • 2.4" wide • 1/8" material  
Steel • Item No. 515GSD • \$20.25

*As Beautiful As They Are Functional!*

**Catalina Balconette**

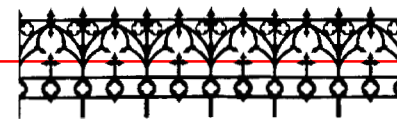

10.36" high • 12" deep • 3/16" material

Width	Item No.	Price	Weight	Width	Item No.	Price	Weight
30"	515BSA30	\$360.75	25 lbs.	42"	515BSA42	\$399.75	31 lbs.
36"	515BSA36	\$377.75	28 lbs.	48"	515BSA48	\$422.00	35 lbs.

*Dress Up Your Windows with America's Most Exquisite Window Box Holder!*

**Catalina Planter/Firebox**

10.36" high • 12" deep • 3/16" material

Width	Item No.	Price	Weight
24"	515PSA24	\$369.00	27 lbs.
36"	515PSA36	\$399.00	40 lbs.

*Beautiful & Functional All Year! See Page 22*

**Catalina  
Mailbox Surround**

11.25" high • 8" wide  
19.5" long • 3/16" material  
515MSA • 12 lbs. • \$179.00

*See Page 22*

**Coordinate Your Roof Crestings with Matching Balconettes**

**A Touch of Class & Authenticity for Your  
Historic or Retro-Architecture Home!  
Available Only from Capital Cresting!**

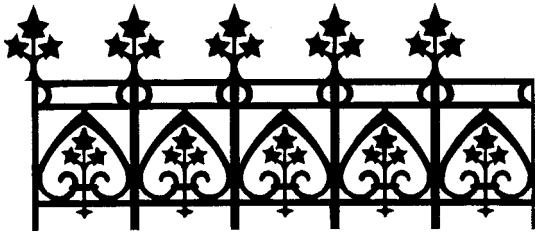

**Astor Place  
Cresting**

Overall Height: 20"  
Overall Length: 47.5"  
Usable Length: 45"

Sample 518SSB - \$25.00 • Refundable with order.

**- CRESTING FABRICATED IN STEEL -**

Item No.	Thickness	Price Each	Weight Each
518CSA	3/16"	\$180.25	15.5 lbs.
518CSB	1/4"	\$189.00	20.5 lbs.
518CSC	3/8"	\$226.00	31.0 lbs.

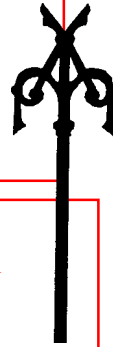

**Astor Place Finial**

35" high • 7" wide • 3/16" material  
Steel • Item No. 518FSA • \$89.75



**Astor Place  
Snowguard**

5" high • 3" wide • 1/8" material  
Steel • Item No. 518GSD • \$19.25

*As Beautiful As They Are Functional!*

**Astor Place Balconette**

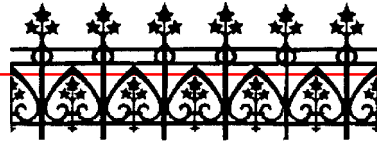

13.5" high • 12" deep • 3/16" material

Width	Item No.	Price	Weight	Width	Item No.	Price	Weight
30"	518BSA30	\$327.00	28 lbs.	42"	518BSA42	\$360.50	35 lbs.
36"	518BSA36	\$347.25	31 lbs.	48"	518BSA48	\$389.50	38 lbs.

*Dress Up Your Windows with America's Most Exquisite Window Box Holder!*

**Astor Place Planter/Firebox**

13.5" high • 12" deep • 3/16" material

Width	Item No.	Price	Weight
24"	518PSA24	\$299.00	30 lbs.
36"	518PSA36	\$399.00	45 lbs.

*Beautiful & Functional All Year! See Page 22*

**Astor Place  
Mailbox Surround**

14.5" high • 8" wide  
19.5" long • 3/16" material  
518MSA • 13 lbs. • \$179.00

*See Page 22*

**23 Stock Designs • Custom Work Available**

**Traditional, Contemporary and Custom Designs  
Gracing Historic Homes Throughout America.  
Available Only from Capital Cresting!**

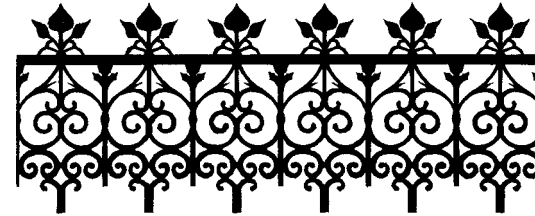

**Savannah  
Cresting**

Overall Height: 19"  
Overall Length: 47.5"  
Usable Length: 47.5"

Sample 531SSB - \$25.00 • Refundable with order.

**- CRESTING FABRICATED IN STEEL -**

Item No.	Thickness	Price Each	Weight Each
531CSA	3/16"	\$239.75	15.5 lbs.
531CSB	1/4"	\$248.75	20.5 lbs.
531CSC	3/8"	\$281.50	31.0 lbs.

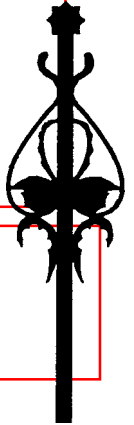

**Savannah Finial**

35" high • 8" wide • 3/16" material  
Steel • Item No. 531FSA • \$118.25



**Savannah  
Snowguard**

5" high • 2.75" wide • 1/8" material  
Steel • Item No. 531GSD • \$19.25

*As Beautiful As They Are Functional!*

**Savannah Balconette**

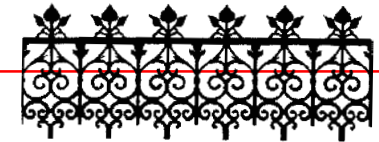

13.75" high • 12" deep • 3/16" material

Width	Item No.	Price	Weight	Width	Item No.	Price	Weight
30"	531BSA30	\$390.25	29 lbs.	42"	531BSA42	\$436.25	36 lbs.
36"	531BSA36	\$416.75	32 lbs.	48"	531BSA48	\$474.00	40 lbs.

*Dress Up Your Windows with America's Most Exquisite Window Box Holder!*

**Savannah Planter/Firebox**

13.75" high • 12" deep • 3/16" material

Width	Item No.	Price	Weight
24"	531PSA24	\$369.00	31 lbs.
36"	531PSA36	\$399.00	46 lbs.

*Beautiful & Functional All Year! See Page 22*

**Savannah  
Mailbox Surround**

15" high • 8" wide  
19.5" long • 3/16" material  
531MSA • 14 lbs. • \$199.00

*See Page 22*

**Made in the America of U.S. Made Materials**

**A Touch of Class & Authenticity for Your  
Historic or Retro-Architecture Home!  
Available Only from Capital Cresting!**

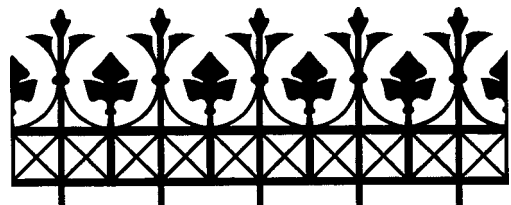

**Tuscany  
Cresting**

Overall Height: 19"  
Overall Length: 47.5"  
Usable Length: 47.5"

Sample 557SSB - \$25.00 • Refundable with order.

**- CRESTING FABRICATED IN STEEL -**

Item No.	Thickness	Price Each	Weight Each
557CSA	3/16"	\$177.50	15.5 lbs.
557CSB	1/4"	\$192.00	21.0 lbs.
557CSC	3/8"	\$215.75	31.0 lbs.

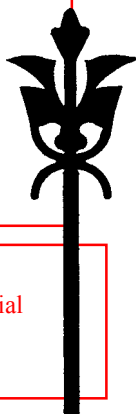

**Tuscany Finial**

35" high • 8.75" wide • 3/16" material  
Steel • Item No. 557FSA • \$87.00



**Tuscany  
Snowguard**

5" high • 4.5" wide • 1/8" material  
Steel • Item No. 557GSD • \$20.50

*As Beautiful As They Are Functional!*

**Tuscany Balconette**



12" high • 12" deep • 3/16" material

Width	Item No.	Price	Weight	Width	Item No.	Price	Weight
30"	557BSA30	\$330.50	27 lbs.	42"	557BSA42	\$363.75	33 lbs.
36"	557BSA36	\$350.50	30 lbs.	48"	557BSA48	\$394.50	37 lbs.

*Dress Up Your Windows with America's Most Exquisite Window Box Holder!*

**Tuscany Planter/Firebox**

12" high • 12" deep • 3/16" material

Width	Item No.	Price	Weight
24"	557PSA24	\$369.00	29 lbs.
36"	557PSA36	\$399.00	43 lbs.

*Beautiful & Functional All Year! See Page 22*

**Tuscany  
Mailbox Surround**

13" high • 8" wide  
19.5" long • 3/16" material  
557MSA • 13 lbs. • \$179.00

*See Page 22*

**23 Stock Designs • Custom Work Available**

**Traditional, Contemporary and Custom Designs  
Gracing Historic Homes Throughout America.  
Available Only from Capital Cresting!**

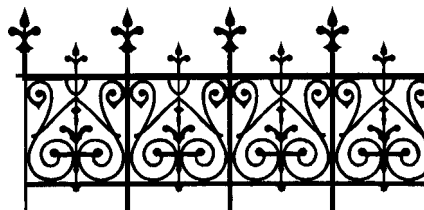

**Carlisle  
Cresting**

Overall Height: 23"  
Overall Length: 47.5"  
Usable Length: 46"

Sample 561SSB - \$25.00 • Refundable with order.

**- CRESTING FABRICATED IN STEEL -**

Item No.	Thickness	Price Each	Weight Each
561CSA	3/16"	\$206.75	13.5 lbs.
561CSB	1/4"	\$228.75	18.0 lbs.
561CSC	3/8"	\$244.50	27.0 lbs.



**Carlisle Finial**

35" high • 8.25" wide • 3/16" material  
Steel • Item No. 561FSA • \$91.50



**Carlisle  
Snowguard**

5" high • 3.75" wide • 1/8" material  
Steel • Item No. 561GSD • \$20.25

*As Beautiful As They Are Functional!*

**Carlisle Balconette**



12" high • 12" deep • 3/16" material

Width	Item No.	Price	Weight	Width	Item No.	Price	Weight
30"	561BSA30	\$375.50	24 lbs.	42"	561BSA42	\$419.00	30 lbs.
36"	561BSA36	\$400.75	27 lbs.	48"	561BSA48	\$452.00	34 lbs.

*Dress Up Your Windows with America's Most Exquisite Window Box Holder!*

**Carlisle Planter/Firebox**

12" high • 12" deep • 3/16" material

Width	Item No.	Price	Weight
24"	561PSA24	\$369.00	25 lbs.
36"	561PSA36	\$399.00	38 lbs.

*Beautiful & Functional All Year! See Page 22*

**Carlisle  
Mailbox Surround**

13" high • 8" wide  
19.5" long • 3/16" material  
561MSA • 12 lbs. • \$199.00

*See Page 22*

**Lightweight • Unbreakable • Easy to Install**

**A Touch of Class & Authenticity for Your  
Historic or Retro-Architecture Home!  
Available Only from Capital Cresting!**

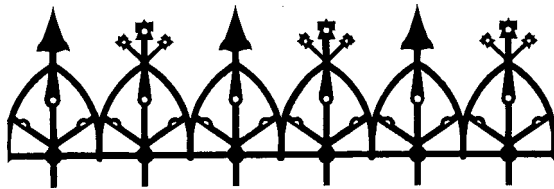

**Graerock  
Cresting**

Overall Height: 16"  
Overall Length: 47.5"  
Usable Length: 47.5"

Sample 568SSB - \$25.00 • Refundable with order.

**— CRESTING FABRICATED IN STEEL —**

Item No.	Thickness	Price Each	Weight Each
568CSA	3/16"	\$175.75	8.50 lbs.
568CSB	1/4"	\$194.50	11.0 lbs.
568CSC	3/8"	\$229.25	17.0 lbs.



**Graerock  
Snowguard**

5" high • 3.25" wide • 1/8" material only  
Steel • Item No. 568GSD • \$20.50

*As Beautiful As They Are Functional!*

**Graerock Finial**

34" high • 6" wide • 3/16" material only  
Steel • Item No. 568FSA • \$84.50

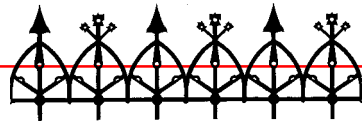

**Graerock Balconette**

11.75" high • 12" deep • 3/16" material

Width	Item No.	Price	Weight	Width	Item No.	Price	Weight
30"	568BSA30	\$263.25	22 lbs.	42"	568BSA42	\$281.75	28 lbs.
36"	568BSA36	\$276.00	25 lbs.	48"	568BSA48	\$299.00	31 lbs.

*Dress Up Your Windows with America's Most Exquisite Window Box Holder!*

**Graerock Planter/Firebox**

11.75" high • 12" deep • 3/16" material

Width	Item No.	Price	Weight
24"	568PSA24	\$259.00	23 lbs.
36"	568PSA36	\$299.00	35 lbs.

*Beautiful & Functional All Year! See Page 22*

**Graerock  
Mailbox Surround**

12.75" high • 8" wide  
19.5" long • 3/16" material  
568MSA • 11 lbs. • \$139.00

*See Page 22*

**Assembly Hardware Included • Easy to Install**

**Traditional, Contemporary and Custom Designs  
Gracing Historic Homes Throughout America.  
Available Only from Capital Cresting!**

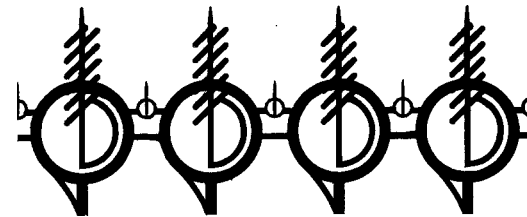

**Cosmopolitan  
Cresting**

Overall Height: 19"  
Overall Length: 47.5"  
Usable Length: 47.5"

Sample 569SSB - \$25.00 • Refundable with order.

**— CRESTING FABRICATED IN STEEL —**

Item No.	Thickness	Price Each	Weight Each
569CSA	3/16"	\$143.00	11.5 lbs.
569CSB	1/4"	\$162.75	15.0 lbs.
569CSC	3/8"	\$191.25	23.0 lbs.



**Cosmopolitan  
Snowguard**

5" high • 3" wide • 1/8" material  
Steel • Item No. 569GSD • \$25.50

*As Beautiful As They Are Functional!*

**Cosmopolitan Finial**

35" high • 5" wide • 3/16" material  
Steel • Item No. 569FSA • \$84.75

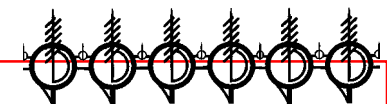

**Cosmopolitan Balconette**

11.75" high • 12" deep • 3/16" material

Width	Item No.	Price	Weight	Width	Item No.	Price	Weight
30"	569BSA30	\$259.75	22 lbs.	42"	569BSA42	\$278.00	28 lbs.
36"	569BSA36	\$268.50	25 lbs.	48"	569BSA48	\$289.75	31 lbs.

*Dress Up Your Windows with America's Most Exquisite Window Box Holder!*

**Cosmopolitan Planter/Firebox**

11.75" high • 12" deep • 3/16" material

Width	Item No.	Price	Weight
24"	569PSA24	\$259.00	23 lbs.
36"	569PSA36	\$299.00	35 lbs.

*Beautiful & Functional All Year! See Page 22*

**Cosmopolitan  
Mailbox Surround**

12.75" high • 8" wide  
19.5" long • 3/16" material  
569MSA • 11 lbs. • \$139.00

*See Page 22*

**Coordinate Your Roof Crestings with Matching Balconettes**

**A Touch of Class & Authenticity for Your  
Historic or Retro-Architecture Home!  
Available Only from Capital Cresting!**

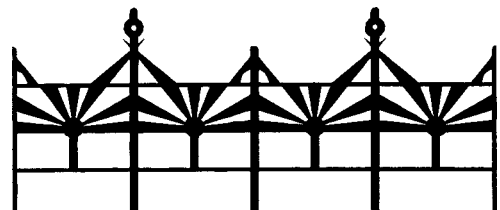

**Art Deco  
Cresting**

Overall Height: 20"  
Overall Length: 47.5"  
Usable Length: 47.5"

Sample 571SSB - \$25.00 • Refundable with order.

**- CRESTING FABRICATED IN STEEL -**

Item No.	Thickness	Price Each	Weight Each
571CSA	3/16"	\$166.50	11.5 lbs.
571CSB	1/4"	\$186.25	15.5 lbs.
571CSC	3/8"	\$215.00	23.0 lbs.



**Art Deco Finial**

35" high • 4.25" wide • 3/16" material  
Steel • Item No. 571FSA • \$79.50  
Aluminum • Item No. 571FAA • \$159.00



**Art Deco  
Snowguard**

4.5" high • 2.5" wide • 1/8" material  
Steel • Item No. 571GSD • \$20.75

*As Beautiful As They Are Functional!*



**Art Deco Balconette**

10.25" high • 12" deep • 3/16" material

Width	Item No.	Price	Weight	Width	Item No.	Price	Weight
30"	571BSA30	\$327.00	22 lbs.	42"	571BSA42	\$359.00	28 lbs.
36"	571BSA36	\$343.50	25 lbs.	48"	571BSA48	\$380.25	31 lbs.

*Dress Up Your Windows with America's Most Exquisite Window Box Holder!*

**Art Deco Planter/Firebox**

10.25" high • 12" deep • 3/16" material

Width	Item No.	Price	Weight
24"	571PSA24	\$299.00	23 lbs.
36"	571PSA36	\$399.00	35 lbs.

*Beautiful & Functional All Year! See Page 22*

**Art Deco  
Mailbox Surround**

11" high • 8" wide  
19.5" long • 3/16" material  
571MSA • 11 lbs. • \$179.00

*See Page 22*

**Elegant • Affordable • Easy to Install**

**Our beautiful designs  
serve many uses beyond their  
intended purpose.**

**On your bookshelves or in your garden,  
Capital Crestings designs serve some surprising functions!**

In addition to their intended uses, crestings, finials and snowguards can serve other functions both practical & decorative. Though crestings are primarily for use on the roof, they also serve beautifully as crestring on masonry walls, either high or low, by adding a decorative touch and serving as additional security. They can also be used as window guards, either individually for small windows such as those found in cellars, or stacked for use on larger windows. In garden gates, they make wonderful and highly decorative grills. In gardens they can serve as low fencing to define flower beds and they add a dramatic emphasis to the overall garden design.

Within the garden, what could be more decorative or useful than a finial or snowguard to serve as a hose guard or to stand alone as a garden ornament? Our finial and snowguard designs can also serve as *objets d'art* as elements in interior design. Used as objects of interest within wall groupings, as a paper weight on the desk, as a free-standing object on a coffee table or credenza, or even fashioned into bookends, our designs can serve many purposes that not only please the eye but serve a practical use as well.

Though our Balconette™ window box holders make a dramatic statement at your windows, they need not function only as window boxes. They can also be used to dress up a plain wall within the garden or within the interior of your home; flower boxes needn't be only at the exterior of your windows. Attached to a wall on your porch near your entryway, they function beautifully as firewood holders; if room allows, they can also be mounted adjacent to your fireplace for the same purpose. With an appropriate liner they can also be used as a highly decorative coal scuttle or a holder for wood pellets. And, of course, they can hold any sort of paraphernalia in the kitchen, laundry room, wet bar, bathroom, mud room or wherever you would like a decorative, durable and functional accent.

Jennifer, Customer Service  
and Shipping



# FINIALS

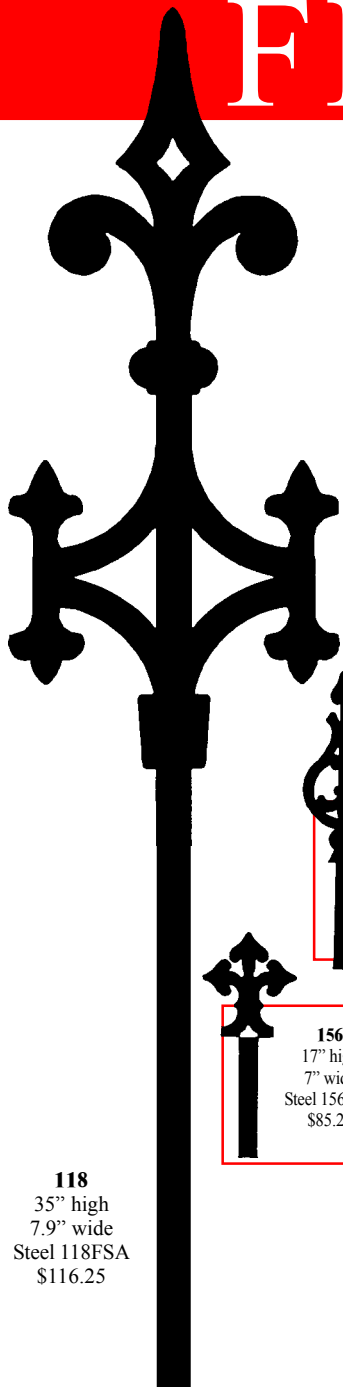

**C**APITAL CRESTINGS™ offers a matching finial, also known as a corner post, for each Capital Crestings design.

Each finial is made by taking a representative section of a Capital Crestings™ design and fabricating it into a four-sided unit welded to a heavy gauge tube which is drilled twice in each direction to make the attachment to the cresting panel a simple affair. The four-sided unit shows off beautifully, no matter what direction you view it from.

As always, Capital Crestings provides the nuts and bolts that you need.

All finials are 3/16" thick plate steel mounted on heavy-gauge steel tubing. Priming and painting are available.

If you are purchasing only finials, we are fully able to design and construct any type of bracket that may be required to install them, for example on a turret roof.

**118**  
35" high  
7.9" wide  
Steel 118FSA  
\$116.25

**156**  
17" high  
7" wide  
Steel 156FSA  
\$85.25

**151**  
31" high  
6" wide  
Steel 151FSA  
\$119.25

**280**  
22" high  
9.75" wide  
Steel 280FSA  
\$72.50

**186-1**  
33" high  
6.25" wide  
Steel 186FSA1  
\$157.25

**186-2**  
33" high  
12" wide  
Steel 186FSA2  
\$158.50

**133**  
28" high  
4" wide  
Steel 133FSA  
\$107.25

**Finials Also Make Great Garden Ornaments!**

<p><b>315</b> 35" h • 7.1" w Steel 315FSA \$112.50</p>	<p><b>383</b> 35" h • 7.25" w Steel 383FSA \$114.50</p>	<p><b>384</b> 35" h • 11.1" w Steel 384FSA \$92.50</p>	<p><b>425</b> 24" h • 12.75" w Steel 425FSA \$87.25</p>	<p><b>429</b> 34.75" h • 9" w Steel 429FSA \$81.50</p>
--	---	--	---	--

<p><b>441</b> 35" h • 8" w Steel 441FSA \$82.50</p>	<p><b>457</b> 28.25" h • 10" w Steel 457FSA \$94.50</p>	<p><b>462-1</b> 30" h • 6" w Steel 462FSA1 \$78.75</p>	<p><b>462-2</b> 35" h • 10.5" w Steel 462FSA2 \$153.00</p>
---	---	--	--

<p><b>465</b> 30" h • 3.5" w Steel 465FSA \$76.75</p>	<p><b>515</b> 33" h • 8" w Steel 515FSA \$81.25</p>	<p><b>518</b> 35" h • 7" w Steel 518FSA \$89.75</p>	<p><b>531</b> 35" h • 8" w Steel 531FSA \$118.25</p>	<p><b>557</b> 35" h • 8.75" w Steel 557FSA \$87.00</p>
---	---	---	--	--

<p><b>561</b> 35" h • 8.25" w Steel 561FSA \$92.50</p>	<p><b>568</b> 34" h • 6" w Steel 568FSA \$84.50</p>	<p><b>569</b> 35" h • 5" w Steel 569FSA \$84.75</p>	<p><b>571</b> 35" h • 4.25" w Steel 571FSA \$79.50</p>
--	---	---	--

# COPPER ROOF CAPS

*Copper Roof Caps add that authentic look to any conical or multi-sided turret roof.*

**T**hese caps are available as a cone, 4, 6, or 8 sided. When ordering be sure to specify number of sides and roof pitch. Returns will not be accepted if this information is provided incorrectly.

Both caps are manufactured in Natural Copper, which weathers much like a penny.



**POINTED  
CAP**



**SCALLOPED  
CAP**

**AVAILABLE WITH  
SEALED POINT OR  
A FINIAL RECEIVER**

# STAND ALONE FINIAL BRACKETS

*Would you like to put a finial on a pitched roof without cresting?  
Well, you need a Stand Alone Finial Bracket!*

**S**tand alone finial brackets are easy to adjust and easy to install. Using basic tools a finial can be installed on any sloped roof peak including a flat surface mount.



**Easy to adjust and  
Easy to install!**



# WELL, HOW DO YOU .... ?

*You'll be surprised at just how easy it is!*

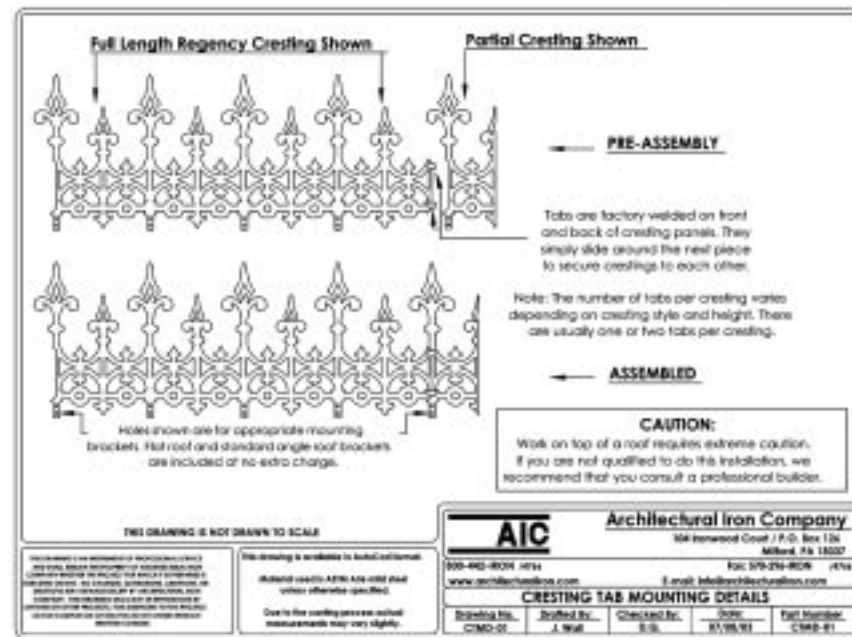
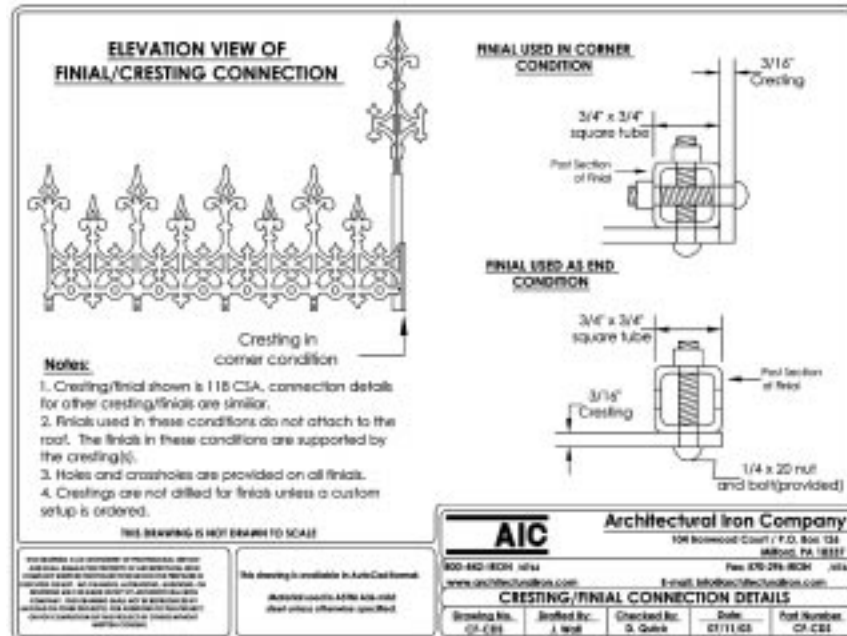

# SNOWGUARDS

## Where Are Your Snowguards?

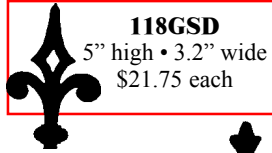

**118GSD**  
5" high • 3.2" wide  
\$21.75 each



**557GSD**  
5" high • 4.5" wide  
\$20.50 each

Also known as iceguards and a common sight in the snow belt, snowguards are designed to prevent snow and ice from cascading off roofs. These little beauties are as functional as they are decorative.

Snowguards are available in styles to match all of our crestings, although they can be used independently of any other decorative roof crestings or finials.

Prices shown for snowguards include priming, painting (black). Shipping and handling charges are extra. *Call us for your snowguard needs; we are the experts!*

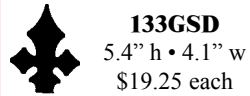

**133GSD**  
5.4" h • 4.1" w  
\$19.25 each

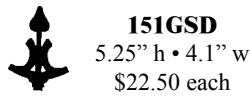

**151GSD**  
5.25" h • 4.1" w  
\$22.50 each

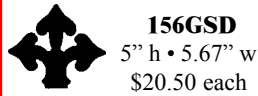

**156GSD**  
5" h • 5.67" w  
\$20.50 each

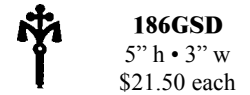

**186GSD**  
5" h • 3" w  
\$21.50 each

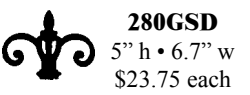

**280GSD**  
5" h • 6.7" w  
\$23.75 each

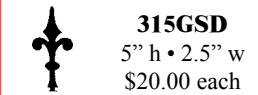

**315GSD**  
5" h • 2.5" w  
\$20.00 each

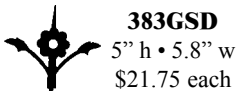

**383GSD**  
5" h • 5.8" w  
\$21.75 each

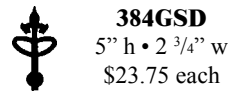

**384GSD**  
5" h • 2 3/4" w  
\$23.75 each

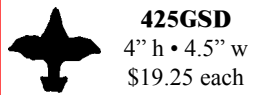

**425GSD**  
4" h • 4.5" w  
\$19.25 each

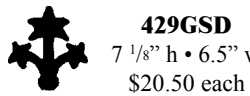

**429GSD**  
7 1/8" h • 6.5" w  
\$20.50 each

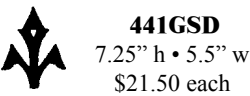

**441GSD**  
7.25" h • 5.5" w  
\$21.50 each

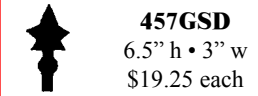

**457GSD**  
6.5" h • 3" w  
\$19.25 each

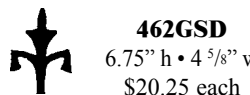

**462GSD**  
6.75" h • 4 5/8" w  
\$20.25 each

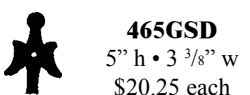

**465GSD**  
5" h • 3 3/8" w  
\$20.25 each

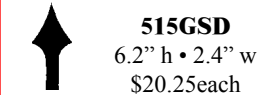

**515GSD**  
6.2" h • 2.4" w  
\$20.25each

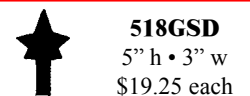

**518GSD**  
5" h • 3" w  
\$19.25 each

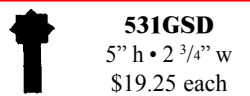

**531GSD**  
5" h • 2 3/4" w  
\$19.25 each

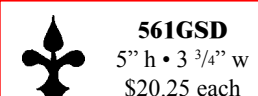

**561GSD**  
5" h • 3 3/4" w  
\$20.25 each

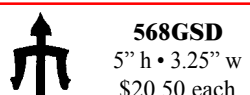

**568GSD**  
5" h • 3.25" w  
\$20.50 each

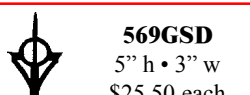

**569GSD**  
5" h • 3" w  
\$25.50 each

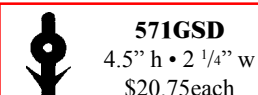

**571GSD**  
4.5" h • 2 1/4" w  
\$20.75each

*Consider some of these little beauties for your roof!*



## UP ON THE ROOFTOP, CLICK, CLICK, CLICK!

*You'll be surprised at just how easy it is!*

- Easy to Install
- Lightweight & Unbreakable
- Assembly Hardware Included
- Easy to Handle Four Foot Lengths

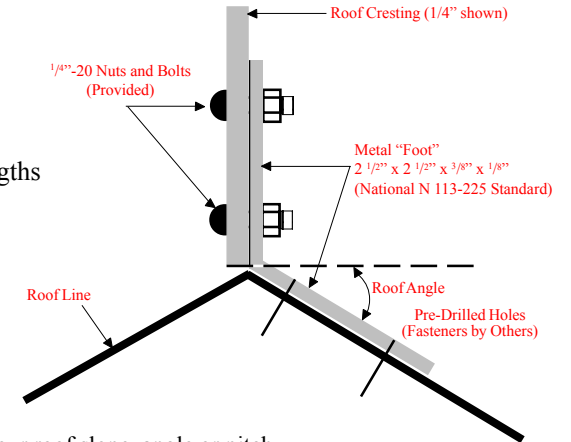

### CRESTRING INSTALLATION DETAIL

1. When ordering, please specify your roof slope, angle or pitch.
2. You may elect to cut and drill on-site, or you may choose an optional custom set up by AIC. If the latter is chosen, no cutting or drilling should be necessary on your roof.
3. For flat-surface mounting, standard anchoring feet are supplied with your order.
4. For mounting over ridge vents, custom straddling brackets are available (see below).

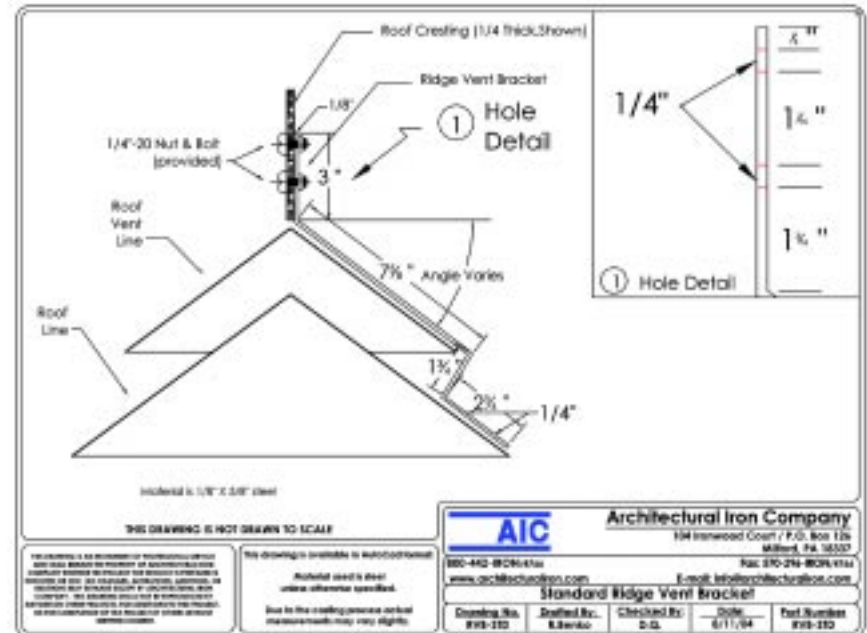

# Capital Balconette™

## America's Premier Window Box Holder

23 Designs in Hundreds of Sizes

Add a touch of class to your home with a new and exciting architectural product that is both elegant and affordable, the finishing touch that will make your home the showplace it deserves to be.

**Fully Assembled**  
**Priced to Fit Your Budget**  
**Guaranteed Unbreakable**

— U.S. Made of U.S. Materials —



- Looks great all year!
  - Easily installs in minutes!
  - 23 standard designs, each in four standard sizes!
  - Custom widths are available to fit your needs...Just Ask!

Capital Balconette™ window box holders are one-piece, fully assembled, primed and painted. They consist of three sides and floor (with built-in mounting brackets) for enclosing flower boxes or dressing up a plain wall or garden wall. All designs are based on our popular Capital Crestings™ crestings and finials.



Style 315, standard finish, custom size, ready for shipping from our foundry in Milford, PA

These easy to install, unbreakable window box holders weigh in the range of 8 to about 40 pounds. All are fabricated in ASTM A 36 plate steel. Capital Balconettes are made with a protective guard rail along the tops of the spires; customers may opt to eliminate this. As are all of our products, Capital Balconettes™ are U.S. made of U.S. materials.

Although we offer a wide variety of styles in stock and ready to ship, we have no problem with custom styles, custom sizes, or even custom colors.

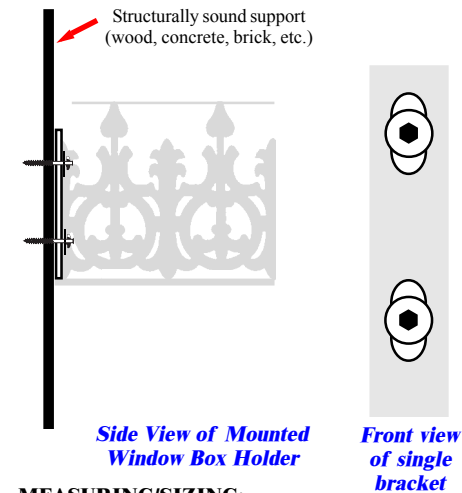
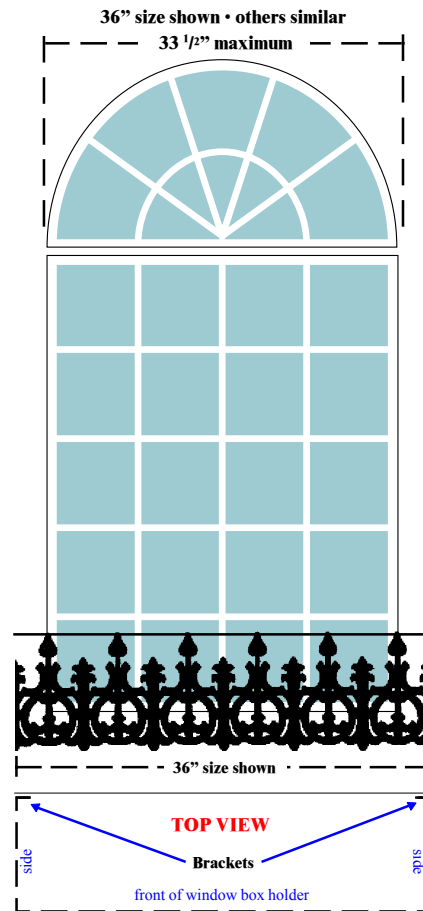

### MEASURING/SIZING:

CAPITAL BALCONETTES™ mount to the wall on both outer sides of the window. The window box holder will fit windows with outer dimensions that are at least 2 1/2" less than the given size of the window box holder. For example, a 36" window box holder will fit around a window no greater than 33 1/2" wide. See picture and diagram.



Style 151 with custom, white finish  
 Home of Jim & Darlene Embury  
 Yorktown Heights, NY



Style 462 with custom, antique-white finish  
 Garden of Dreams • Purdys, NY

**WARNING!** Capital Balconettes™ are not designed to support more than the average flower box and or flower pots. They are not to be used as a step or a balcony. Any use as a step or to support a person or persons could lead to severe injury and must be avoided. Suggested mounting procedures and materials are provided, but it is the responsibility of the purchaser to see that the Capital Balconettes™ are adequately installed for normal usage.

# Firewood/Planter Boxes

*Elegant and Practical Units for Use Year-Round*

**Summer or winter, these beauties work hard!**

Similar in construction to the balconette, our firewood / planter box combination units use the same 23 styles and materials as our other products. Basically a balconette with a 4th side and legs added, these units have the same durable and aesthetic qualities that make all of our products a striking focal point in any home.

In the warmer months you can proudly display your flowers in this unit any way you choose! You can insert pots, trays, wood boxes, just about anything you like into these units for flower displaying purposes. Then in the off season, move the unit inside and have a decorative yet sturdy storage box for your firewood, kindling, paper, whatever you need!

Each unit comes fully assembled and finished. Each unit also comes with 1 set of removable legs. You decide which size legs you would like to order with the unit: 3, 6, 9 or 12 inches. The legs are easily removed so you can alter the height of the unit to best suit your individual needs.

Once again, you have a lifetime guarantee against breakage, so you know that it's going to last!

The boxes come standard in two different sizes; 12" x 24" and 12" x 36" (that is the size of the floor). The height of each unit would be the same as the corresponding balconette unit.



Style 133- Standard Finish



Style 315 - Custom, White Finish



### DO YOU HAVE A PHOTO OR STORY?

*Be a part of our website project photo gallery! We'd love to see our products in use at your home. Send along your photo, and there's a good chance that it will be included on our website.*

Architectural Iron Co. • P.O. Box 126 • Milford, PA 18337  
info@capitalcrestings.com

*The Capital Crestings crew is professional, friendly, and helpful! We're here to help!*

Jon Roberts, AIC & Capital Crestings Factotum

# Mailbox Surrounds

*Enhance and Protect One of Life's Necessities!*

**Have you ever been the victim of "mailbox baseball?"**

Destruction of mailboxes is a national problem. If yours hasn't already been demolished, you could easily be the next victim. Perhaps you feel secure about the safety of your mailbox, but you're tired of that boring box at the end of your beautiful driveway and property.

We've talked to many people who are in one or both of these categories, and that's why we have added our most recent product, the mailbox surround, to our line.

Made from plate steel and welded together for the ultimate strength, our surrounds both protect and enhance an item that for many is a necessity!

All units are available in the same 23 styles as our other products so you can easily find one to complement your home! Each mailbox surround comes completely assembled, with a mailbox, so all you need to do is mount it to a pole or timber.

All units are approximately 8" wide and 19.5" long. The heights are generally slightly taller than the corresponding balconette of the same style.

The first thing many people see when arriving at your home is your entranceway which generally includes your mailbox. Make that first impression a good one, with the protection and beauty of a mailbox surround!



Style 118 - Standard Finish



Style 557 - Custom, White Finish

### Speaking of mailboxes...Hey! We get letters!



"Dear Mr. Quick -

We are well pleased with your product. Thank you again for helpful and knowledgeable service.

Mary M. Lam"

La Conner, WA

"To Whom It May Concern:

Just wanted to let you know how pleased we are with the finials we purchased. They were actually better than I expected.

Thanks  
Bob & Dot Cole"

Bangor, PA

## Boring Technical Stuff You Should Read Before Ordering!

### MATERIALS:

All **CAPITAL CRESTING™** designs are fabricated in lightweight, ASTM A 36 plate steel, making them affordable, easy to handle, easy to install, economical to ship and unbreakable.

### MEASURING:

When measuring and ordering your cresting design, we suggest that you order an **additional 5%** to accommodate for loss in cutting and fitting at installation.

### PRICES:

Prices quoted for crestings are for 47.5"± unprimed lengths with bolt-on feet for peaked roofs and integral cresting-to-cresting locking tabs. Shipping and handling charges are extra, and under normal circumstances do not exceed 15% of the order total. Pricing for all **CAPITAL CRESTING™** styles, including crestings, finials, and snowguards, includes all necessary nuts and bolts.

### PRIMING AND PAINTING:

Priming of your **CAPITAL CRESTING™** purchase is available at a \$20.00 per cresting panel or per finial charge. Likewise, a finish coat of quality, black enamel paint is available at a \$30.00 per cresting panel or per finial charge. **Note** that the prices quoted for all other products include priming and painting (black).

Benjamin Moore custom colors can be ordered; please inquire about charges.

### SHIPPING:

Most orders are shipped within two weeks of receipt. Depending on the size and weight of your order, we will ship it by United Parcel Service or one of several common carriers. Carriers cannot deliver to a post office box, so we do need a street address.

### EXCHANGES, RETURNS & WARRANTY:

We do not offer refunds or exchanges on orders. We do, however, offer replacement on merchandise which is defective in materials or workmanship.

Tom Dayton - Shop Foreman  
AIC Master Welder, Foundryman  
and Local Volunteer Firefighter

A return authorization code must be obtained from us for any agreed upon return and replacement under this warranty. This code must be prominently shown on the return shipment.

No other warranty is expressed or implied. Roof crestings, finials and snowguards are not intended or designed for use as lightning rods. All damages other than replacement of defective merchandise are excluded, including consequential damage or loss.

### DAMAGES:

Damages in transit are the responsibility of the carrier, so in the unlikely event that you should receive a damaged shipment, save all packing materials and notify the carrier promptly.

**Please note** that we frequently ship to California, Washington, Oregon, Hawaii and Canada have yet to experience a problem in shipping.

### CUSTOM DESIGNS AND SIZING:

We are frequently asked to reproduce crestings that you may already have. This can be done quite economically from an existing original, a tracing of that original, or, if neither of those is available, from a clear, head-on photograph.

Another frequent request is for one of our stock designs to be modified in height or length. This can also be done easily and economically.



## More Boring Technical Stuff You Should Read!

### CUSTOM SETUPS:

We can provide prefabrication service for you if you provide us with exact dimensions of your roof surface.

If you elect to have us prefabricate the cresting to accurate dimensions, no cutting or drilling should be necessary on your roof. Please call our customer service representatives for this service. There is a minimum \$200.00 charge for this service.

### SAMPLES:

Representative samples (only 12", not full panels) of all **CAPITAL CRESTING™** designs are available at a \$25.00 per panel charge, which is refundable with your order placed within 60 days. Shipping charges are additional.

To be eligible for credit, samples must be returned postpaid to Architectural Iron Company prior to shipment of your cresting order.

### SIGNED ORDERS:

We do require a signature on all orders as an acknowledgment that you are aware of the necessity of providing electrical grounding for your **CAPITAL CRESTING™** products.

### ROOF SLOPE & MOUNTING FEET:

For those customers who intend to mount their crestings on a sloped roof, all **CAPITAL CRESTING™** can be "customized" to your sloped roof with pre-drilled, galvanized steel anchoring feet. These anchoring feet are included with your order. However, to insure accurate fit, you must supply your roof slope (angle or pitch) with your order. Any qualified contractor should be able to tell you your roof slope.

For flat-surface mounting, standard anchoring feet are supplied with your order.

### MOUNTING OVER RIDGE VENTS:

For those customers who have continuous ridge vents on their homes, we also offer a straddling bracket to accommodate installation. We will require your roof slope.

Dana Presto, Lead Man

### A NOTE TO ARCHITECTS:

We have produced 8.5 x 11 drawings, each with an elevation, of all of our standard **CAPITAL CRESTING™** designs. If you need one to incorporate into your architectural renderings, or for any other use, please call 800-442-IRON/4766, and we will be happy to mail, fax, or e-mail it to you at no charge.

All products in this catalogue are available, upon request, in AutoCAD format for inclusion in your drawings.

### DO IT YOURSELF?

The question is not so much **can you**, but **should you**? Let's face it, roofs are not intended for us to be on; that's why sidewalks were invented, which is where we belong. Kidding aside, roofs can be a dangerous place to be.

Installation of **CAPITAL CRESTING™** or any other roof feature should be left to experienced, insured professionals. We will be happy to answer any questions regarding this. **Call 800-442-IRON/4766.**

Note: Product specifications, pricing and availability may change at any time without prior notice.

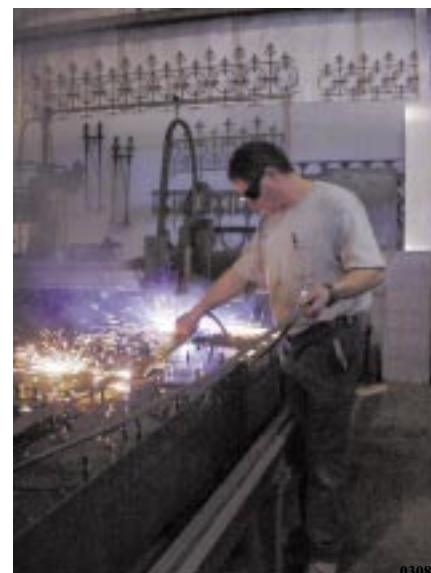

# ORDERING INFORMATION:

**ALL ORDERS:**

For Capital Crestings™ orders it is recommended that you **order 5% additional cresting** to allow for loss in cutting and fitting. To assure accurate crest-to-roof fit, you must supply the angle or pitch of your roof in the space provided on the order form.

All orders require a 50% deposit. This deposit may be paid by personal or company check made payable to Architectural Iron Co., postal money order, or it may be charged to your MasterCard or Visa.

The balance of your order must be paid by postal money order, Visa or Mastercard at the time of shipment. Personal or business checks will be accepted for final payment only if certified or if you are a business with an established ARCHITECTURAL IRON COMPANY account. Final payment with personal or company check will result in your order being held 10 business days to allow the check to clear.

**MAIL ORDERS:**

To order by mail, simply fill out the enclosed order form by providing the style number of the cresting/finial/snowguard/window box holder/firewood-planter box/mailbox surround that you wish to purchase, the thickness desired, the quantity needed and whether you wish the items to be primed and painted. We do require a signature on all orders whether you are charging your order to a credit card or not. The spaces provided to calculate prices will aid you in determining the cost of your order exclusive of shipping charges, which are determined by the weight of the order and the distance that it must be shipped. **Make checks payable to Architectural Iron Company.**

**TELEPHONE ORDERS:**

Telephone orders are accepted from 8:00 a.m. to 3:30 p.m. (Eastern Time) Monday through Friday at 800-442-4766 or 570-296-7722. We are happy to process your order in this manner and get your CAPITAL CRESTINGS™ order underway. We will need to receive your completed and signed order form by mail prior to your order being shipped.

**SALES TAX:**

Sales tax must be charged to all Pennsylvania and New York customers or on any order that is picked up at our facility in Milford, Pennsylvania.

**FAX ORDERS:**

If you intend to charge your order to your credit card, fill out the enclosed order form completely and then FAX the completed order form to CAPITAL CRESTINGS™ at 570-296-4766. Be sure to include the required Visa or MasterCard information. We will bill your credit card for the required 50% deposit and your order will be entered into our production schedule. Shipping and handling charges will be added..

**USING THE STYLE SELECTOR SHEET:**

The enclosed transparency sheet showing the designs offered by CAPITAL CRESTINGS™ is to help you to visualize our cresting styles on **your** roof. From a safe spot on the ground where you can see your roof through the style selector, view CAPITAL CRESTINGS™ on your roof.

**Stock crestings are not designed to be installed up a slope, that is to say, they should be installed level from left to right.**

**Orders are fabricated to your needs and may not be cancelled or returned without a written authorization!**

**WARNING:**

**All crestings, finials and snowguards must be grounded** according to all applicable codes. Consult appropriate authorities for requirements in your area. It is the purchaser's responsibility to ground all crestings, finials and snowguards properly as well as to inform the property owners to inspect and maintain all grounding mechanisms periodically. Crestings, finials and snowguards are neither designed nor intended to be used as lightning rods.

*— please print and return this entire page - both upper and lower portions —*



## CAPITAL CRESTING™

P.O. Box 126 • 104 Ironwood Court  
Milford, PA 18337  
**570-296-7722 • 800-442-IRON/4766 • FAX 570-296-IRON/4766**

# ORDER FORM

**METHOD OF PAYMENT**

- Check Payable to Architectural Iron Co.**
- Money Order
- MasterCard
- Visa



Item No.	Product	Thickness	Qty.	Price Each	Priming \$20 each	Black Paint \$30 each	Total

--	--	--	--	--	--	--	--	--	--	--	--	--	--	--	--	--	--	--

16 Digit Account Number

--	--	--	--

Expires

Custom Set-Up Charge  
Inquire About Charges, If Any  
Merchandise Total

Sales Tax (if applicable) and shipping charges will be added at the time of shipping.

**BILLING INFORMATION:**

Cardholder Name \_\_\_\_\_

Company Name \_\_\_\_\_

Mailing Address \_\_\_\_\_

City/State/Zip \_\_\_\_\_

Daytime Phone \_\_\_\_\_ Fax \_\_\_\_\_

e-mail address \_\_\_\_\_

**SHIP TO:**

ROOF SLOPE (ANGLE OR PITCH) \_\_\_\_\_

Name \_\_\_\_\_

Company Name \_\_\_\_\_

Street Address \_\_\_\_\_

City/State/Zip \_\_\_\_\_

*I have read and understand the above information on grounding.*

Signature \_\_\_\_\_

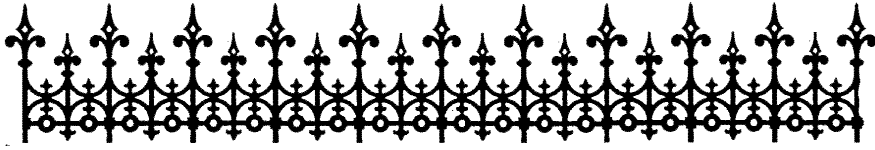

***Why Not Come Up and See Us Sometime?***

**AN INVITATION  
FROM DON QUICK,  
President, Architectural Iron Company**

If you are going to be in the Milford, PA area, our shops are open for visitors Monday through Friday from 8:00 a.m. to 3:00 p.m.

Please try to call ahead (570-296-7722), as we do not have formal tours, but we'd be happy to provide directions to our foundry, and to meet with you to show you how CAPITAL CRESTINGS and our other products are made.



***We do everything within our power to make your  
CAPITAL CRESTING purchase a pleasant experience.***

**W**hen you call, please be advised that we do not have voice mail or endless commercial messages, just real people. Occasionally, if our phones are particularly busy, or if you have a technical question beyond the skills of

our customer-service staff, we may take your name and phone number and ask to call you back. We always return your call as quickly as possible.

We truly appreciate your order and answer your questions in a friendly, intelligent manner.

We welcome your suggestions and comments, and we'd love to have you visit us someday.



Melissa, bookkeeping

***NEW*** from **CAPITAL CRESTINGS™**

***CUSTOM GRILLES***

To beautify the registers and returns in the floors and walls of your home, we have added a new product to our line of home improvement products!

These custom grilles are **not** mass produced, They are custom-designed and manufactured to **your** needs.

Send us a photo, a drawing, or a sample of your design, and we will recreate the classic look of any cast-iron grille you wish in any color you prefer.

Be artistically unique! Design your own pattern and e-mail or fax us your sketch. We'll do the rest.



Style AIC-1  
11 x 11  
Finished and ready  
for shipment

***OTHER CUSTOM WORK***



Custom Radiused Bronze Lettering  
for the Bromley Condominium, NYC

**ARTWORK & SCULPTURE**

We have worked with a number of high-profile artists on projects ranging from art fences to steel cut-outs used in the interior of a home.

**SPECIALTY SHAPES**

If you can draw it, we can cut it!

**FIGURES**

Free-form figures; alone, with props, at work, you name it, we've done it.

**SIGNAGE**

Custom signs combining lettering and design to meet your needs, whatever they may be.



## ***If It's Made Of Metal, We Can Make It!***

Architectural Iron Company has a long tradition of meeting our clients' needs from restoration work to stock items to custom-design jobs.

New to our product line is this stunning 36" diameter glass-topped coffee table made using the same process employed in creating our crestings and finials. The steel is treated with our proprietary SB-2 processing to be visually indistinguishable from cast iron and finished with a high quality black enamel. \$379<sup>00</sup> plus shipping, handling and taxes where applicable. Add \$96 for 3/16" tempered glass top. Other sizes available; call for prices.



## ***A Gracious Addition to Your Home!***



This totally custom six-sided greenhouse (the open end nearest our plant goes against the residence) will be fitted with custom Hope's windows, as well as custom-made flat and curvilinear insulated glass. It was designed to be lifted by crane to a terrace high above a prestigious New York City address. Client misfortune leaves the job incomplete and available for purchase. Interested? Call for more information.

This project is typical of custom, high-end jobs undertaken by the artisans at Architectural Iron Company. It represents 2,133 hours of labor to date.

## ***If You Can Visualize It, We Can Make It! Custom Work Is Our Middle Name!***



Fabrication of unique public works projects is another aspect of work done by Architectural Iron Company. This unique, multi-layer "World Fence" for the internationally acclaimed artist Fred Wilson was constructed for a new high school in Flushing, NY. Design copyright Fred Wilson.



## **ARCHITECTURAL IRON COMPANY**

*fabricators & restorers of cast iron architectural elements*  
serving the cause of historic preservation of America's architectural heritage, and meeting the needs of designers, planners & architects in today's construction industry.

### **SOME OF OUR HISTORIC RESTORATION WORK:**

Grand Central Station, NYC • Port Authority Trans-Hudson Entrance Kiosk, Hoboken, NJ  
The Dakota, NYC • Grant's Tomb, NYC • Blair House, Washington, DC • Neptune Fountain, Snug Harbor Cultural Center, Staten Island, NY • Cleveland Federal Reserve Bank, Cleveland, OH • U.S. Customs Courthouse, New Orleans, LA • Saginaw Art Museum, Saginaw, MI • numerous historic residences & sites throughout the USA

### **SOME OF OUR CONTEMPORARY FABRICATION:**

Commemorative Fence at Jim Thorpe School, Brighton Beach, NY  
American Airlines Terminal Art Fence at JFK Airport, NY  
World Fence, Townsend Harris High School, Queens, NY  
Wonderland Station, Revere Beach, MA

***incidentally, we are the nation's largest manufacturer of cast iron sash weights***

visit us on the internet at [www.capitalcrestings.com](http://www.capitalcrestings.com)

